



BXR2100 Fifth Wheel Hitch

(Attaches to most 2-5/16" Gooseneck Balls)
Installation Instructions

Serial Number

Please read these Installation Instructions in their entirety prior to installing or operating this equipment.



This hitch is rated to 21,000 lbs. Gross Towing Weight and 5,000 lbs. Tongue Weight

Note: When using the Blue Ox 5th Wheel Hitch with a Rota-Flex Pin Box a BXR9005 Rotaflex Lockout Kit is required.

! WARNING

Refer to your vehicle's owner's manual for maximum towing capacity. **DO NOT** exceed vehicle, tongue or hitch weight ratings - failure to follow vehicle manufacturer's recommendations could result in damage to your vehicle, personal injury or death.

! WARNING

Failure to read and follow these instructions could result in separation of the trailer from the truck, causing property damage, loss of towed vehicle, personal injury or death.

BXR2100
Fifth Wheel Hitch
(Attaches to most 2-5/16" Gooseneck Balls)
Installation Instructions

 **WARNINGS**

- The weight rating of the hitch assembly must be greater than the gross weight of the trailer.
- Trailer brakes are required.
- Without proper information, towing can be dangerous. Understand all risks involved with towing before starting. For more information on towing safety, see “**The Trailer Handbook: A Guide to Understand Trailer and Towing Safety**” from the *National Association of Trailer Manufacturers*, www.NATM.com.
- **Do not** alter this product in any way. Modifying this product could change the integrity and lead to a loss of connection between the trailer and the tow vehicle.
- Check that all bolted connections are at the correct torque specification on a regular basis. Complete a visual inspection before towing each time.
- Before using hitch make sure that the locking pin is in place.
- Ensure that installation is performed by someone who is aware of the risks and has knowledge of hazards and proper safety procedures involved with adding components to the chassis of a vehicle and the tools needed for installation.
- Make sure that the bed of the truck is clean of dirt and debris before starting installation.
- While the vehicle is in motion do not hold or force the handle in any direction. Stand clear of the handle while hooking up and unhooking. Failure to do so may result in serious injury.
- Roughly 15-25% of the weight of the trailer should be on the hitch.
- Always insure the king pin is locked into the hitch head prior to towing.
- Only use a SAE 2" king pin with the Blue Ox Fifth Wheel Hitch.
- Hitch is not intended for use on a flat bed truck.

Maintenance/Care

- **Periodically clean any dirt/debris from the hitch. Moderately lubricate locking pin on hitch head with white lithium grease or equivalent grease.**

NOTICE

- If a removable bed liner is installed, it should be removed or modified to allow the hitch to contact the bed directly. Spray-in bed liners are permissible.
- **Do not** use any devices that change the king pin pivot point. The king pin should rotate in the hitch head.
- It is recommended to always check the clearances between the truck cab and trailer in both towing and maneuvering positions. Measuring from the center of the coupler to the back of the cab and from the center of the king pin to the corner of the trailer will show the available clearances. It is also recommended to check clearances between the bed sides and underside of trailer to allow for any pitch of the trailer and that the trailer is level as possible during towing.

Recommendation:

Y (1/2 the trailer width) + 4" = X (Distance between the back of the truck cab and the center of the rear truck axle)

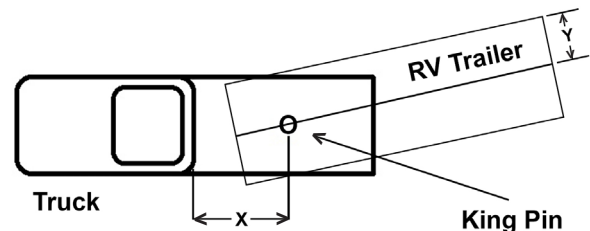

- The gooseneck ball must be properly locked in position.
- Dealer or installer be certain the user receives these instruction sheets.
- If the hitch is in an accident, it must be replaced. **DO NOT** use it again! An accident can cause unseen damage and using it again could result in more damage or serious injury. **DO NOT** use the hitch if it is damaged or missing parts.
- Recommend using the BXR9004 Lube Plate on hitch head to help prevent wear to the top plate surface.

BXR2100
Fifth Wheel Hitch
(Attaches to most 2-5/16" Gooseneck Balls)
Installation Instructions

Tools Required

Torque Wrench
19MM 12 Point Socket
11/16" Socket
15/16" Deep Wall Socket
5/8" Wrench

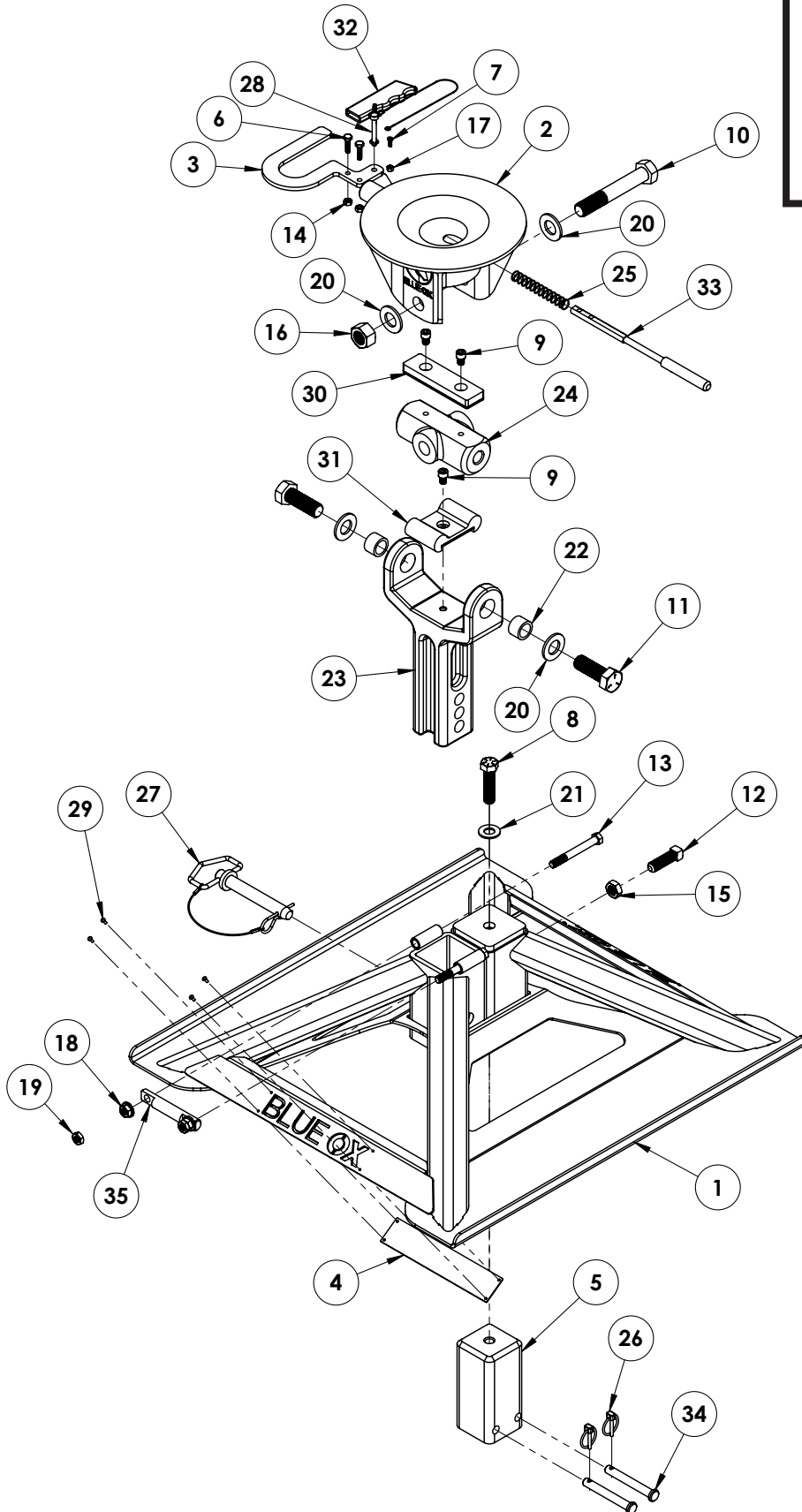

BXR2100
Fifth Wheel Hitch
(Attaches to most 2-5/16" Gooseneck Balls)
Installation Instructions

Item No.	Part No.	Description	Qty.
1.....	61-8472.....	Base.....	1
2.....	61-8478.....	Hitch Head.....	1
3.....	101-10678.....	Handle Plate.....	1
4.....	101-10760.....	Backing Plate.....	2
5.....	110-0066.....	Gooseneck Coupler Casting.....	1
6.....	201-0071.....	1/4"-20 x 1" Hex Head Bolt, Grade 5, ZP.....	2
7.....	201-0371.....	#8-32 x 1/2" Socket Head Cap Screw.....	1
8.....	201-0763.....	5/8"-11 x 2-1/2" Hex Head Bolt, Grade 8, FT, ZP.....	1
9.....	201-1037.....	3/8"-16 x 1/2" Socket Head Cap Screw.....	3
10.....	201-1118.....	7/8"-9 x 5-1/2" Hex Head Bolt, Grade 5, ZP.....	1
11.....	201-1120.....	7/8"-9 x 2-1/2" Hex Head Bolt, Grad 5, ZP.....	2
12.....	201-1121.....	5/8"-11 x 2" Cup Point Set Screw, Allow Steel.....	1
13.....	201-1154.....	7/16"-14 x 3-3/4" Hex Head Bolt, Grade 5, ZP.....	2
14.....	202-0023.....	1/4"-20 Hex Lock Nut, Center Dimple.....	2
15.....	202-0061.....	5/8"-11 Hex Jam Nut, ZP.....	1
16.....	202-0188.....	7/8"-9 Hex Nut, Center Dimple, ZP.....	1
17.....	202-0247.....	#8-32 Nylon Insert Lock Nut, ZP.....	1
18.....	202-0248.....	7/16"-14 Whiz Flange Nut, ZP.....	2
19.....	202-0249.....	7/16"-14 Jam Nut, ZP.....	2
20.....	203-0039.....	7/8" Flat Washer, ZP.....	4
21.....	203-0106.....	5/8" SAE Flat Washer, ZP.....	1
22.....	207-1195.....	1.219 OD x .906 ID x .813 L Bushing, Bronze.....	2
23.....	210-0213.....	Center Post Casting.....	1
24.....	210-0223.....	Pivot Block Casting.....	1
25.....	222-0185.....	.60 x 4.25 x .049 DIA. Compression Spring.....	1
26.....	229-0829.....	3/16" x 1-1/4" Lynch Pin.....	2
27.....	229-1150.....	3/4" x 4-1/4" Eff Clevis Pin w/Lanyard & Cotter Pin.....	1
28.....	229-1165.....	1/4" x 2" Wire Lock Pin w/ 12" Lanyard.....	1
29.....	229-1229.....	1/8" x .4" Rivet w/ 1/4" Head, Black.....	8
30.....	250-0308.....	Custom Rubber Bumper.....	1
31.....	250-0313.....	Front/Back Rubber Bumper.....	1
32.....	250-0316.....	1" x 1/4" Rectangular Grip w/ Finger Grooves, Blk.....	1
33.....	299-0804.....	Locking Pin, ZP.....	1
34.....	299-0858.....	1/2" DIA. x 3-3/8" EFF. Pin, ZP.....	2
35.....	299-0886.....	Cross Bar Immobilizer, ZP.....	1

Important:

Use only genuine factory replacement parts on your hitch. Do **NOT** substitute homemade or non-typical parts. If a bolt is lost or in need of replacement, for your safety and the preservation of your hitch, be sure to use a replacement bolt of the same grade (In most cases it will be Grade 5, please reference the parts list above). Replacement parts may be ordered through your nearest Blue Ox® Dealer or Distributor. Failing to follow and/or altering these installation instructions in either installation or required equipment will void the manufacturer's warranty.

BXR2100
Fifth Wheel Hitch
(Attaches to most 2-5/16" Gooseneck Balls)
Installation Instructions

Hitch Base Initial Assembly/Installation Instructions

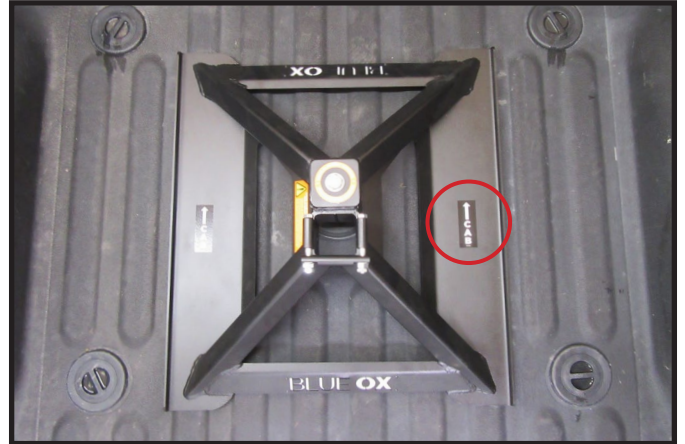

1. Place the base of the hitch onto the gooseneck 2-5/16" hitch ball so that the arrow on each side of the base points towards the cab of the truck.

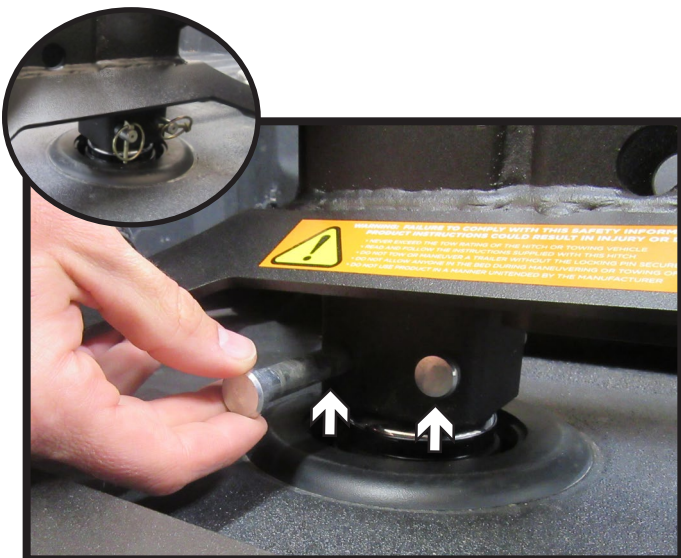

2. Insert two (2) 1/2" x 3-3/8" pins into bottom holes in the hitch base and secure with lynch pins (inset).



3. Using a 15/16" socket and torque wrench tighten the top bolt on the hitch base to 45 ft/lbs.

BXR2100
Fifth Wheel Hitch
(Attaches to most 2-5/16" Gooseneck Balls)
Installation Instructions



4. Hand tighten the bolt on the cab side of the hitch base. Then using a 19MM 12 point socket and torque wrench, tighten the square head bolt to 100 ft/lbs.



5. Hand tighten the jam nut on the cab side of the hitch base. Then using a 15/16" deep wall socket and torque wrench, tighten the jam nut to 120 ft/lbs.

BXR2100
Fifth Wheel Hitch
(Attaches to most 2-5/16" Gooseneck Balls)
Installation Instructions

Hitch Head Initial Installation Instructions



1. Insert the center post of the hitch head into hitch base with the handle towards the driver side of the truck.



- 2a. Insert the 3/4" x 4-1/4" clevis pin. Wrap lanyard inside base arms and insert cotter pin (inset).



- 2b. Recommended clearance between truck bed and 5th wheel trailer is 6-8 inches, (inset). Ensure the trailer is as level as possible, pin box adjustment may be required. To adjust the height of the hitch head remove the clevis pin and adjust appropriately.

BXR2100
Fifth Wheel Hitch
(Attaches to most 2-5/16" Gooseneck Balls)
Installation Instructions



3. Removed loosely installed jam nuts. Tighten down the two (2) 11/16" flange nuts evenly then torque to 54 ft/lbs. Make sure that all slop has been removed from the center post.



4. Install a 11/16" jam nut onto each bolt and tight both jam nuts evenly. Torque jam nuts to 54 ft/lbs.

BXR2100
Fifth Wheel Hitch
(Attaches to most 2-5/16" Gooseneck Balls)
Installation Instructions

Release Handle for Hook Up



1. Remove locking pin from hitch handle.

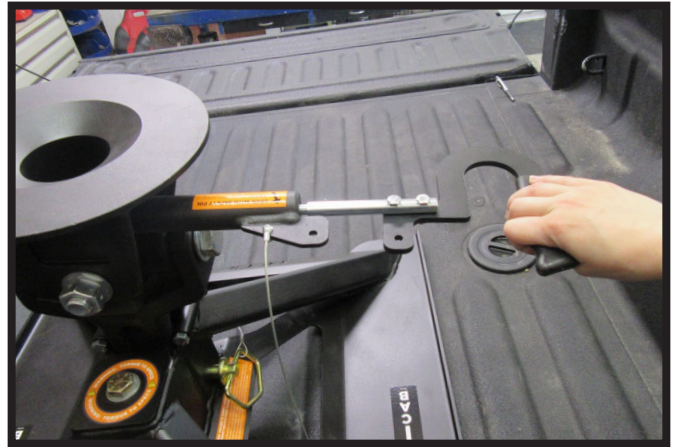

2. Pull handle outward.

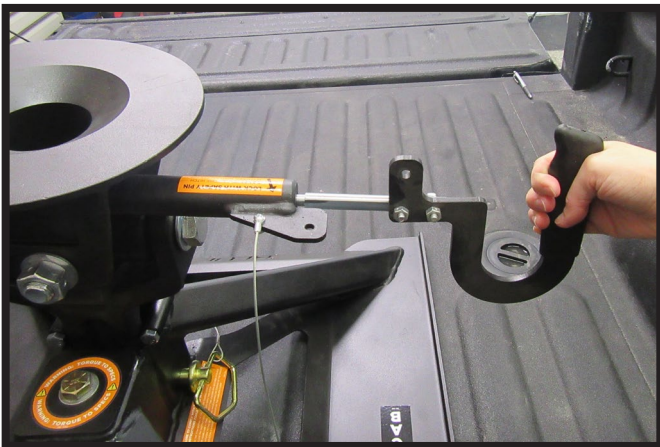

3. Turn handle clockwise till in the open position as shown. Handle will remain in this position until hook-up.

Note: Verify that the handle is in the locked position before reinstalling locking pin.



4. Once hitch is hooked up to the king pin of the trailer, turn handle and reinstall locking pin.

BXR2100
Fifth Wheel Hitch
(Attaches to most 2-5/16" Gooseneck Balls)
Installation Instructions

Attaching the Trailer

Place wheel chock on each side of the trailer wheels. Remove the safety pin from the coupler handle on the hitch head. Turn handle clockwise till in the open position as shown on page 9, step #3. Handle will remain in this position until hook-up. Adjust the height of the trailer so that the king pin is slightly above the top of the coupler. Confirm that lube plate is attached to the trailer's king pin. Slowly back the truck towards the trailer, making sure that the king pin is center with the coupler. Once king pin is over the center or slightly rear of center and within the inner coupler circle, lower trailer until the king pin engages hitch head (Figure 1). Ensure that the coupler handle is completely in the locked position before reinserting the safety pin into the handle. Before towing, connect the electrical cable and breakaway. Close and latch tailgate.

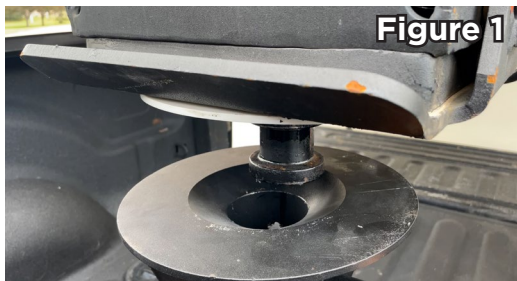

Unhooking Trailer

Lower the landing gear on the trailer to rest firmly on the ground so that load is level with truck suspension. Chock the wheels of the trailer. Lower truck tailgate. Remove the pin from the coupler handle. Pull and rotate handle to the open position. Raise the trailer until the tongue weight is removed from the truck and the king pin is above the hitch head. Disconnect electrical and breakaway. Move the truck forward from underneath trailer. Rotate handle back to the locked position and reinsert the safety pin to lock the handle in closed position.

Pull Test

Slightly raise the landing gear of the trailer. Do not stand between the trailer and the truck bed. Release the emergency brakes on the truck and apply the trailer brakes. Slowly try to pull the trailer forward. The wheel chocks and trailer brakes should not allow the truck to move forward if the hitch is properly connected. The trailer will separate from the truck if it is not properly connected. If the trailer separates from the truck the landing gear will prevent the trailer from dropping or falling on the sides of the truck bed. Completely raise trailer jacks. Check for proper clearance between truck box and trailer as stated on page 7, Step 2b. Remove and store wheel chocks.

Uninstalling Hitch

First remove the hitch head by loosening the driver side and tailgate side jam nuts and bolts. Then remove the 3/4" x 4-1/4" pin. Pull hitch head/center post out of base and set aside. To remove base, loosen cab side jam nut and bolt. Then loosen top bolt on hitch base. Finally remove the two (2) 1/2" x 3-3/8" pins from hitch base and lift to remove base from gooseneck ball.

BXR2100
Fifth Wheel Hitch
(Attaches to most 2-5/16" Gooseneck Balls)
Installation Instructions

Hitch Accessory Kits

BXR9003	Kit, 5th Wheel Wall Mount
BXR9004	Kit, Lube Plate, 10"
BXR9005	Kit, Rotaflex Lockout
BXR9006	Kit, 5th Wheel Bed Mat

Other Accessory Kits

BX88356	Kit, Wiring Harness
BX88360	Kit, King Pin Lock

CUSTOMER SERVICE COMMITMENT

Blue Ox® is committed to providing you with exceptional customer care throughout your lifetime with our products. Our team is here to assist you with any questions you may have regarding the performance of your product. Simply call (402) 385-3051 and you can speak with our technical service team.

Additionally, please visit our website to see which rallies our Destination America team will be attending. For a nominal fee, our service technician will service your towing system to ensure it's in proper working condition. Also, as a commitment to our customers, should you visit our factory, you can stay at our full service Blue Ox® campground at no charge along with enjoying a factory tour.

Again, thank you for being our customer and for the confidence you have shown in the performance of our products. It is because of customers like you we enjoy the success we have today.

© 2015 Blue Ox
One Mill Road, Industrial Park
Pender, Nebraska 68047
Phone: (402) 385-3051
Fax: (402) 385-3360
www.blueox.com

BLUE OX ORIGINAL PURCHASERS LIMITED LIFETIME WARRANTY

Automatic Equipment Manufacturing Company ("Automatic") warrants to the original (first) retail purchaser that this product, manufactured by Automatic, shall be free from defect in material and workmanship under normal use and service for as long as the original retail purchaser owns the product.

During said period, Automatic will repair or replace any parts that have been returned by the original purchaser, to the factory, transportation prepaid, and in Automatic's sole and absolute opinion found to be defective.

Limitations on Warranty Coverage:

Coverage under this warranty will be valid only if the customer warranty card is returned by the original purchaser within 30 days of purchase.

Coverage under this warranty will be effective only when a copy of the original invoice, showing date and place of purchase, accompanies any claim for warranty. This warranty is NON TRANSFERABLE.

This limited warranty will not cover, in any way or form, any alleged damages caused by incorrect or improper installation, improper use, modification or neglect of product, failure to properly service and maintain, misuse, act of God, accident or failure of the user to follow guidelines contained in the instructional material provided by Automatic.

This warranty does not cover normal wear and tear, paint or rust.

Warrantor assumes no responsibility to the owner for loss of use of product, loss of time, inconvenience or any other damage consequential or otherwise. Including, but not limited to mileage, expense of transporting of product, return shipping expense, mechanics travel time, telephone, road service, towing, and rental during repairs, travel, lodging, loss or damage to personal property or loss of earnings.

REPAIR OR REPLACEMENT AS SET FORTH IN THIS LIMITED WARRANTY IS THE SOLE EXCLUSIVE REMEDY OF THE PURCHASER. AUTOMATIC SHALL NOT BE LIABLE FOR ANY INCIDENTAL OR CONSEQUENTIAL DAMAGES FOR BREACH OF ANY EXPRESS OR IMPLIED WARRANTY ON THIS PRODUCT. EXCEPT TO THE EXTENT PROHIBITED BY APPLICABLE LAW, ANY IMPLIED WARRANTY OF MERCHANTABILITY OR FITNESS FOR A PARTICULAR PURPOSE ON THIS PRODUCT IS LIMITED IN LENGTH TO THE DURATION OF THIS WARRANTY.

Please visit <http://blueox.com/warranty/> to register your warranty

