



BX3523

2009-13 Suzuki Grand Vitara Installation Instructions

Serial Number

Attachment Tab Height: 21-1/2"

Attachment Tab Width: 24"

Please read BOTH these Installation Instructions and the General Instructions prior to installing or operating this equipment.

- Blue Ox® towing products and accessories are intended to be installed by Blue Ox® Dealers who are familiar with our products and have the equipment and knowledge necessary to do "fit work". If needed, Blue Ox® Dealers can be found at www.blueox.com or by contacting our Customer Care Department at (402) 385-3051.
- Many Blue Ox® baseplates are designed to use existing holes and hardware to mount the baseplate to the towed vehicle. Even though bolts are there, do not assume they are adequate for baseplate mounting. Always use the hardware supplied in the hardware kit and existing hardware as specified in the installation instructions.



If the front of your vehicle looks different than this, please contact us at (402)385-3051.

Reference your vehicle owner's manual for manufacturer's towing specifications.

Bolt Torque Specifications
Torque in Foot-Pounds for Metric Bolts

Bolt Size	Grade 8.8	Grade 10.9
6MM	6	8
8MM	16	22
10MM	31	40
12MM	54	70
14MM	89	117

Bolt Torque Specifications
Torque in Foot-Pounds for Inch Bolts

Bolt Size	Grade 5	Grade 8
1/4"	10	14
5/16"	19	29
3/8"	33	47
7/16"	54	78
1/2"	78	119
5/8"	154	230

! WARNING

Failure to read and follow these instructions could result in separation of the towed vehicle from the tow bar, causing property damage, loss of towed vehicle, personal injury or death.

BX3523
2009-13 Suzuki Grand Vitara
Installation Instructions

Instruction Notes: The fascia, upper grille, driver side headlight and metal bumper are removed and reinstalled for the baseplate installation. Some drilling and trimming is required.

Place all components that are removed on a flat, sturdy surface. All items will be reinstalled unless otherwise noted after the baseplate is installed.

The dimensional variations between otherwise identical vehicles can be considerable. While the baseplate was designed for easy installation, it may be necessary to tailor the baseplate slightly to compensate for vehicle manufacturer's tolerances.

The BX8869 Tail Light Wiring Kit is recommended for this vehicle.

NOTICE

- Handling of some cosmetic parts when installing this product may require the use of protective covers, rags, specialty tools, etc. to prevent damage.
- When using power drills be aware of the dangers of torque and drill bit length.
- When using a reciprocating saw be aware of objects behind the cutting surface.
- Use a good quality paint to spray cut edges of frame to prevent rusting.
- Be sure that **ALL** electrical connections are plugged in and accessories are functioning properly before reinstalling the fascia.
- Do not use the towed vehicle for storing luggage, equipment, etc. This may cause you to exceed the towing capacity of the tow bar, baseplate and its accessories.
- Be sure to use Loctite® Red on all bolts before tightening. Tighten all bolts according to the torque chart provided.
- Dealer or installer be certain the user receives these instruction sheet.
- If the baseplate is in an accident, it must be replaced. **DO NOT** use it again! An accident can cause unseen damage and using it again could result in more damage or serious injury. **DO NOT** use the baseplate if it is damaged or missing parts.

BX3523

2009-13 Suzuki Grand Vitara

Installation Instructions

Tools Required

- Large Vise Grips
- Flat Screwdriver
- Utility Knife
- Phillips Screwdriver
- Torque Wrench
- Drill
- Reciprocating Saw
- Tape Measure
- Loctite® RED
- 1-1/4" Hole Saw
- 13/32" Drill Bit
- 10MM Socket
- 12MM Socket
- 9/16" Socket
- 9/16" Wrench
- 5/8" Wrench

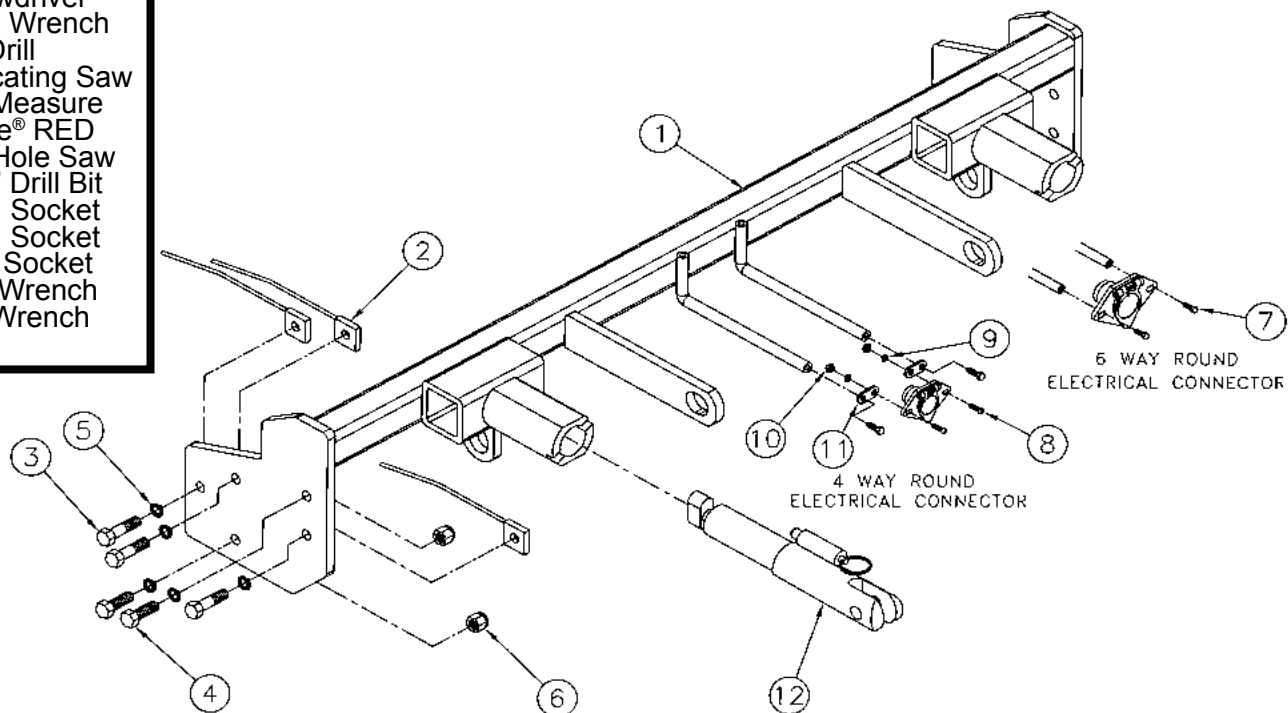

Item No.	Part No.	Description	Qty.
1.....	61-6646	BX3523 Baseplate.....	1
2.....	61-5208	3/8"-16 Nut Plate w/14" Wire	6
3.....	201-0440	3/8"-16 x 1-1/2" Hex Head Bolt, Grade 5, ZP	6
4.....	201-0368	3/8"-16 x 1-1/4" Hex Head Bolt, Grade 5, ZP	4
5.....	203-0010	3/8" Lock Washer, ZP	10
6.....	202-0090	3/8"-16 Nylon Insert Lock Nut, ZP	4
7.....	201-0979	#12-14 x 1" Self Drilling Screw, ZP.....	2
8.....	201-0192	#10-32 1/2" Round Slotted Head Screw.....	2
9.....	203-0054	#10 Lock Washer, ZP	2
10.....	202-0047	#10-32 Hex Nut	2
11.....	101-5822	4 Way Connector Adapter	2
12.....	62-3469	Attachment Tab Assembly	2
13.....	226-0046(not shown)	Class III Safety Cables	2
14.....	229-0359(not shown)	3/8" Quicklink, ZP	4
15.....	290-0437(not shown)	Black Cap Plug Receiver.....	2

Important:

Use only genuine factory replacement parts on your baseplate. Do NOT substitute homemade or non-typical parts. If a bolt is lost or in need of replacement, for your safety and the preservation of your baseplate, be sure to use a replacement bolt of the same grade (In most cases it will be Grade 5, please reference the parts list above). Replacement parts may be ordered through your nearest Blue Ox® Dealer or Distributor, or call our Customer Care Team at (402)385-3051. Failing to follow and/or altering these installation instructions in either installation or required equipment will void the manufacturer's warranty.

BX3523
2009-13 Suzuki Grand Vitara
Installation Instructions

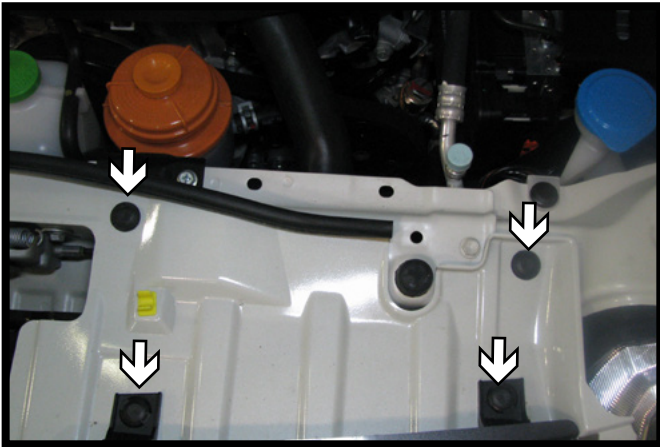

1. Remove the eight (8) pushpins from the top of the grille, four (4) on each side of the vehicle. Lift the grille up and then pull forward to release from the four (4) clips at the bottom and one (1) on either side of the grille.

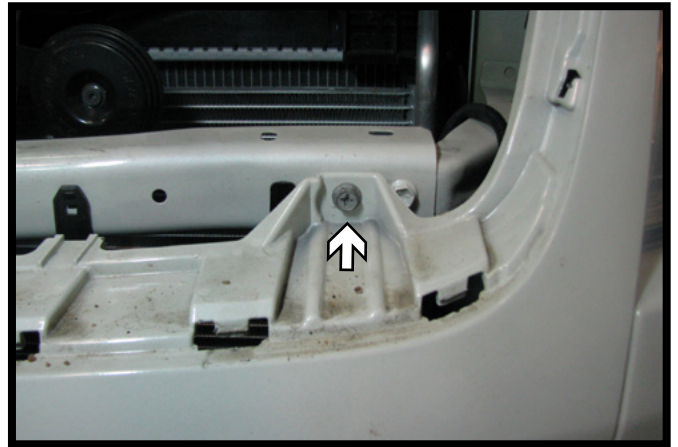

2. Using a 10MM socket, remove the bolt from the fascia between the headlights and just behind where the grille was removed. Do this on both sides of the vehicle.



3. Remove the two (2) pushpins from the lower wheel well (left). Using a 10MM socket, remove the one (1) screw from the upper wheel well (right). Do this on both sides of the vehicle.

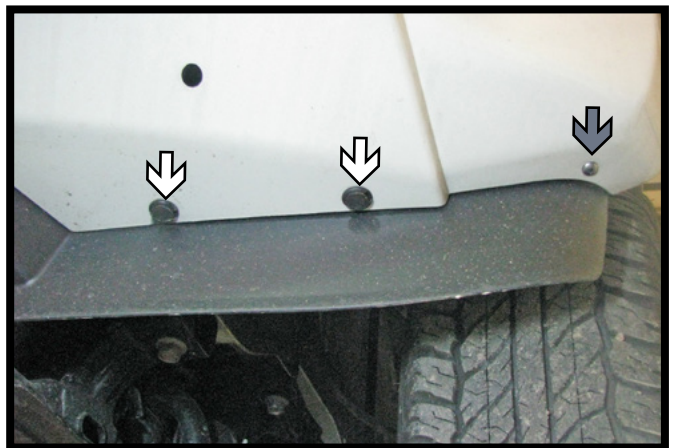

4. Using a Phillips screwdriver, remove the screw from the outer edge of the fascia (gray). Then remove the two (2) push pins (white). Do this on both sides of the vehicle.

BX3523
2009-13 Suzuki Grand Vitara
Installation Instructions

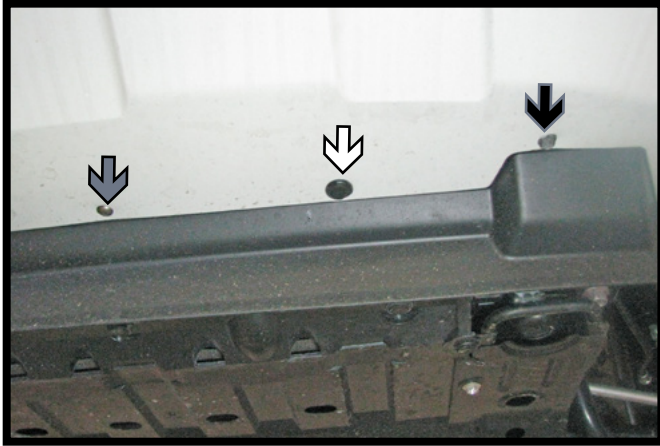

5. Using a Phillips screwdriver, remove the screw from the center of the fascia (gray). Remove the two (2) push pins, one on each side of the vehicle (white). Then using a 10MM socket, remove the two (2) screws, one on each side of the vehicle (black).

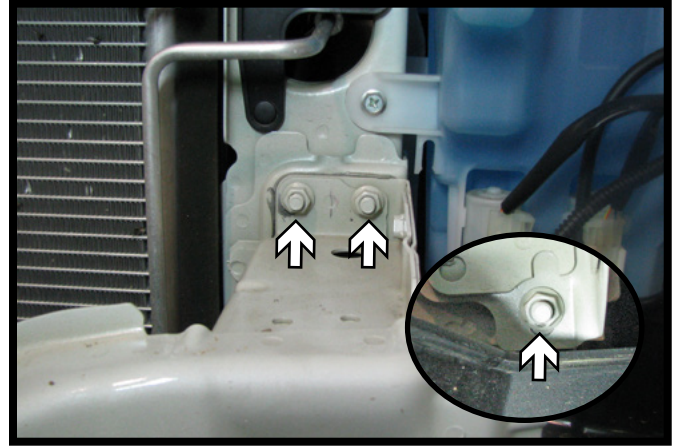

6. Using a 12MM socket, remove the three (3) bolts from the metal bumper. There are two (2) on the top and one (1) on the bottom. Do this on both sides of the vehicle.

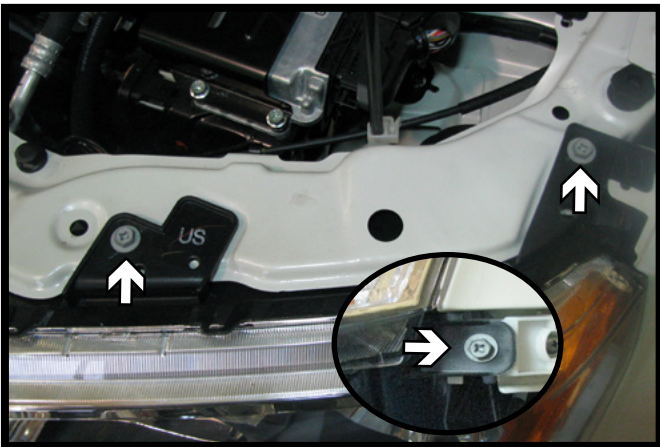

7. On the driver side headlight only, using a 10MM socket, remove the two (2) screws from the top and the one (1) lower screw. Disconnect the headlight and set aside.

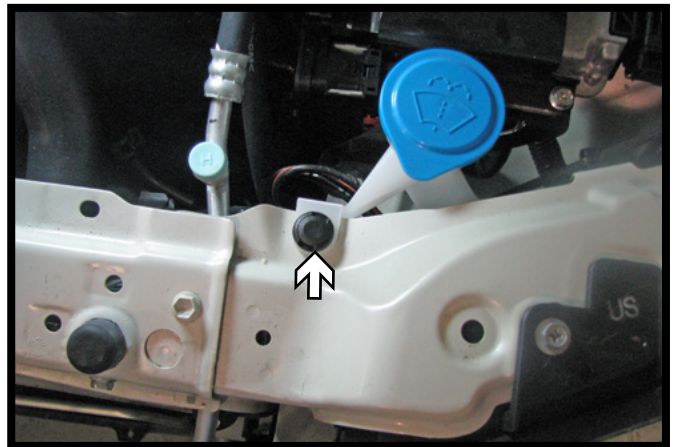

8. Remove the push pin from the filler neck and pull the neck out of the washer reservoir.

BX3523
2009-13 Suzuki Grand Vitara
Installation Instructions

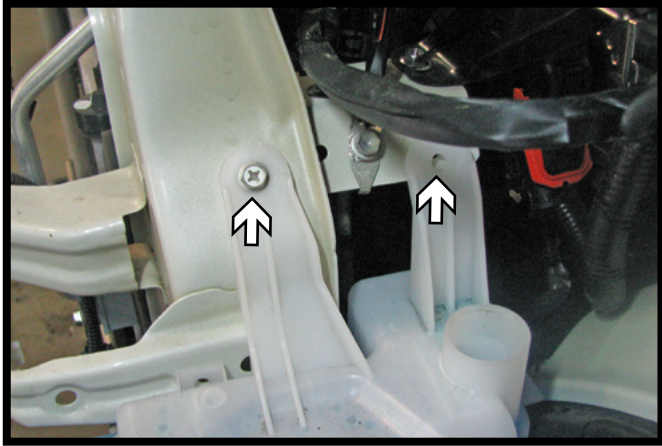

9. Using a 10MM socket, remove the two (2) screws from the top of the washer reservoir.

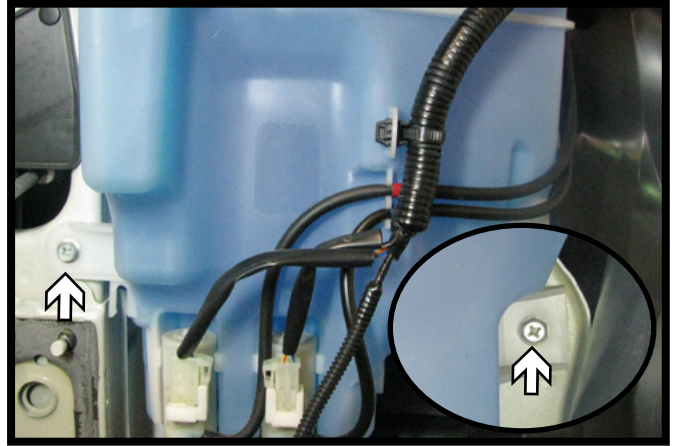

10. Using a 10MM socket, remove the front screw (left) and the screw behind the reservoir (right). Disconnect and plug the lines.

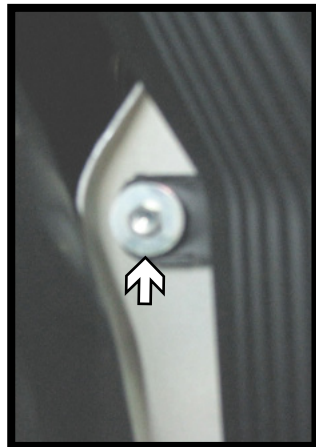
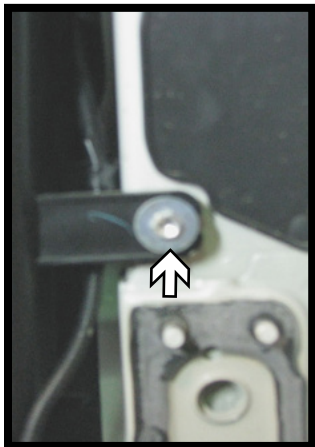

11. On the passenger side air baffle, using a 10MM socket, remove the front screw (left) and the back screw (right).

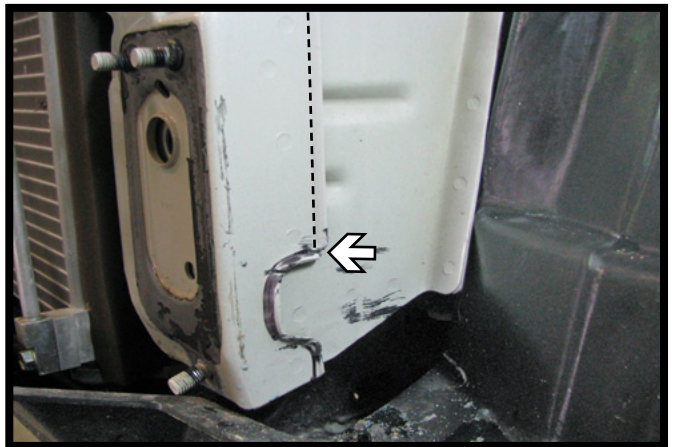

12. Using a reciprocating saw, cut a slit approximately where the arrow shows. Bend the upper section back flush with the frame. Cut the remaining lower lip off flush with the frame. Do this on both sides of the vehicle.

BX3523
2009-13 Suzuki Grand Vitara
Installation Instructions

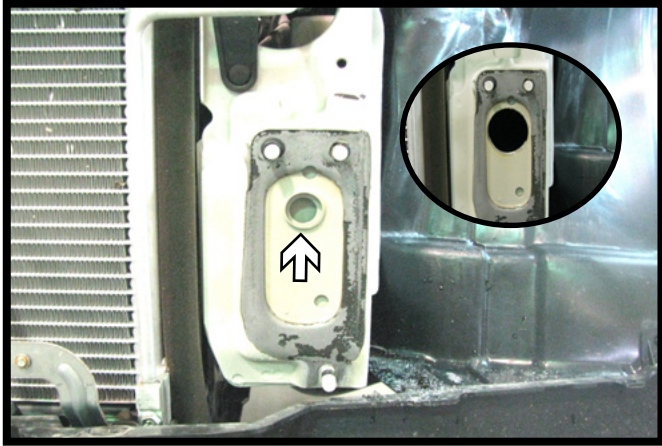

13. Using a 1-1/4" hole saw, enlarge the existing hole on the front of the frame rail. Do this on both sides of the vehicle.

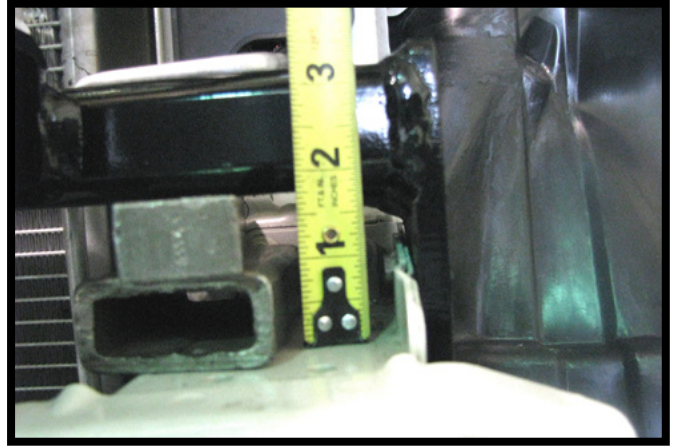

14. Temporarily reinstall the bumper onto the vehicle. Slide the baseplate onto the vehicle. Space the bottom of the baseplate 1-3/4" up from the bumper. Do this on both sides of the vehicle.

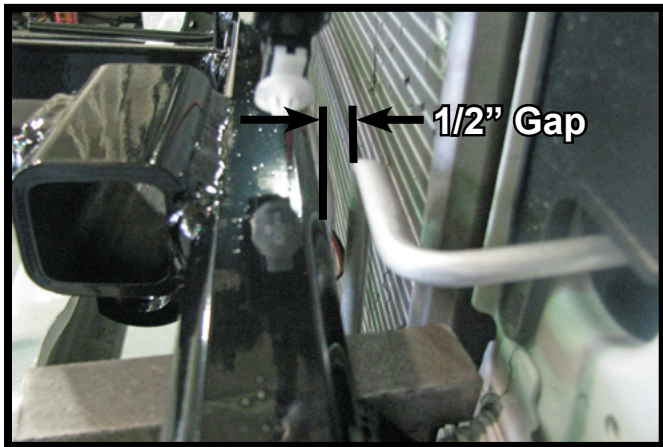

15. Slide the baseplate forward so there is a 1/2" gap between the backside of the baseplate and the coolant lines. Do this on both sides of the vehicle.

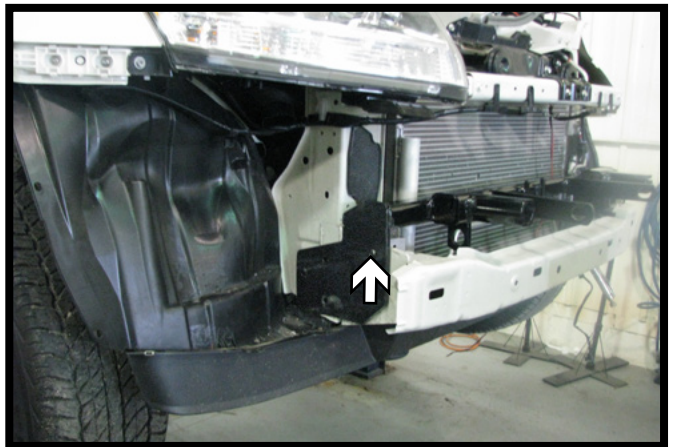

16. With the baseplate in position, clamp securely. Using the baseplate as a template, drill the front top hole with a 13/32" drill bit. Temporarily install a 3/8"-16 x 1-1/4" hex bolt and 3/8"-16 lock nut. Do this on both sides of the vehicle. Once the fasteners are tightened, continue drilling the remaining holes.

BX3523
2009-13 Suzuki Grand Vitara
Installation Instructions

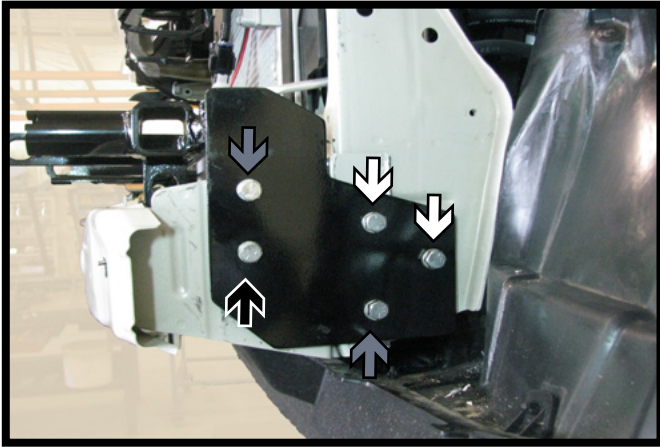

17. After the holes are drilled, remove the bumper and install 3/8"-16 x 1-1/2" bolts, 3/8" lock washers and 3/8" nut plates into the back holes using the 1-1/4" hole drilled in the frame earlier (white). Do this on both sides of the vehicle. Reinstall the bumper and install 3/8"-16 x 1-1/4" bolts, 3/8" lock washers and 3/8"-16 lock nuts on the top and bottom holes (gray). Then on the remaining front hole, install a 3/8"-16 x 1-1/2" bolt, 3/8" lock washer and 3/8" nut plate using the existing hole in the bumper (black). Do this on both sides of the vehicle.



18. Attach the permanent baseplate safety cables to the provided convenience link on the baseplate. The photo above shows the recommended installation of the cables to frame of vehicle. Additional options may interfere with suggested mounting; in this case, secure the cables to a solid piece of the frame as described in the instructions included with the permanent baseplate safety cables. Be sure the safety cables do not rub against any hoses or moving parts. Do this on **BOTH** sides of the vehicle.

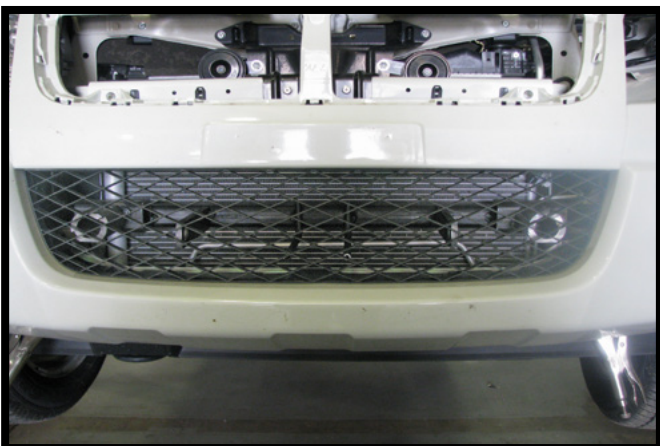

19. Align the fascia as close to its original position, mark and trim as needed to clear the attachment tabs, convenience links and electrical rods.
Reinstall the air baffle, driver side headlight, fascia and upper grille.

BX3523
2009-13 Suzuki Grand Vitara
Installation Instructions



Shown with removable tabs installed



Shown without removable tabs installed

CUSTOMER SERVICE COMMITMENT

Blue Ox® is committed to providing you with exceptional customer care throughout your lifetime with our products. Our team is here to assist you with any questions you may have regarding the performance of your product. Simply call (402) 385-3051 and you can speak with our customer care team.

Additionally, please visit our website to see which rallies our Destination America team will be attending. For a nominal fee, our service technician will service your towing system to ensure it's in proper working condition. Also, as a commitment to our customers, should you visit our factory, you can stay at our full service Blue Ox® campground at no charge along with enjoying a factory tour.

Again, thank you for being our customer and for the confidence you have shown in the performance of our products. It is because of customers like you we enjoy the success we have today.

© 2012 Blue Ox
One Mill Road, Industrial Park
Pender, Nebraska 68047
Phone: (402) 385-3051
Fax: (402) 385-3360
www.blueox.com