



Baseplate Installation Instructions

BX2227 2003-05 Honda Pilot Installation Instructions

Serial Number

Please read BOTH these Installation Instructions and the General Instructions before attempting to install or operate this equipment.

- Blue Ox® towing products and accessories are intended to be installed by Blue Ox® Dealers who are familiar with our products and have the equipment necessary and knowledge to do "fit work". When necessary Blue Ox® Dealers can be found at www.blueox.com or by contacting our Customer Care Department at (402) 385-3051.
- Many Blue Ox® Baseplates are designed to use existing holes and hardware to mount the baseplate to the towed vehicle. Even though bolts are there, do not assume they are adequate for baseplate mounting. Always use hardware supplied in the hardware kit and existing hardware specified in the Baseplate Installation Instructions.

Attachment Tab Height: 25.5"

Attachment Tab Width: 24"

Bolt Torque Specifications
Torque in Foot-Pounds for Metric Bolts

Bolt Size	Grade 8.8	Grade 10.9
6MM	6	8
8MM	16	22
10MM	31	40
12MM	54	70
14MM	89	117

Confirm the towability and pre-towing procedures for your vehicle with the owner's manual or contact the vehicle's manufacturer for specific towing procedures.

Bolt Torque Specifications
Torque in Foot-Pounds for Inch Bolts

Bolt Size	Grade 5	Grade 8
1/4"	10	14
5/16"	19	29
3/8"	33	47
7/16"	54	78
1/2"	78	119
5/8"	154	230



If the front of your vehicle looks different than this, call us at (402) 385-3051.

! WARNING

Failure to read and follow these instructions could result in separation of the towed vehicle from the tow bar, causing property damage, loss of towed vehicle, personal injury or death.

BX2227

2003-05 Honda Pilot

Installation Instructions

Parts List

Ref. No.	Qty.	Part #	Description
1	1	61-5808	Weldment, Baseplate, BX2227
2	4	61-5589	Weldment, 3/8-16 Nut plate
3	4	61-5208	Weldment, Nut Plate, 1/4X1X1, 3/8"/14"Wire
4	2	102-6682	Backing, Plate, BX1015
5	12	201-0440	3/8-16 x 1 1/2" Hex Bolt, Grd. 5, ZP
6	12	203-0010	3/8 Lock Washer, ZP
7	12	203-0003	3/8 Flat Washer, ZP
8	4	202-0003	3/8-16 Hex Nut, ZP
9	4	201-0446	8MM-1.25 x 30MM, Hex Bolt, Grd. 8.8, ZP
10	4	203-0102	8MM Lock Washer, ZP
11	2	201-0553	1/4-20 x 1/2" Hx. Wshd, Type F Screw
12	2	201-0192	#10-32 X 1/2" Slot, Rd. Hd. Screw
13	2	203-0054	#10 Lock Washer
14	2	202-0047	#10-32 Hex Nut
15	2	101-5822	Adapter, 4 Way Connector
16	2	62-3468	Attachment Assembly, SF/SB (R)
	2	226-0046	Baseplate Safety Cable, 36" CL III (Not Shown)
	2	229-0359	Quicklink, 3/8, ZP (Not Shown)
	2	290-0437	Cap Plug, Black (Not Shown)

Tools Required

- 8MM Socket
- 10MM Socket
- 12MM Socket
- 13MM Socket
- 13/32" Drill Bit
- Vise Grips
- LOCTITE Red

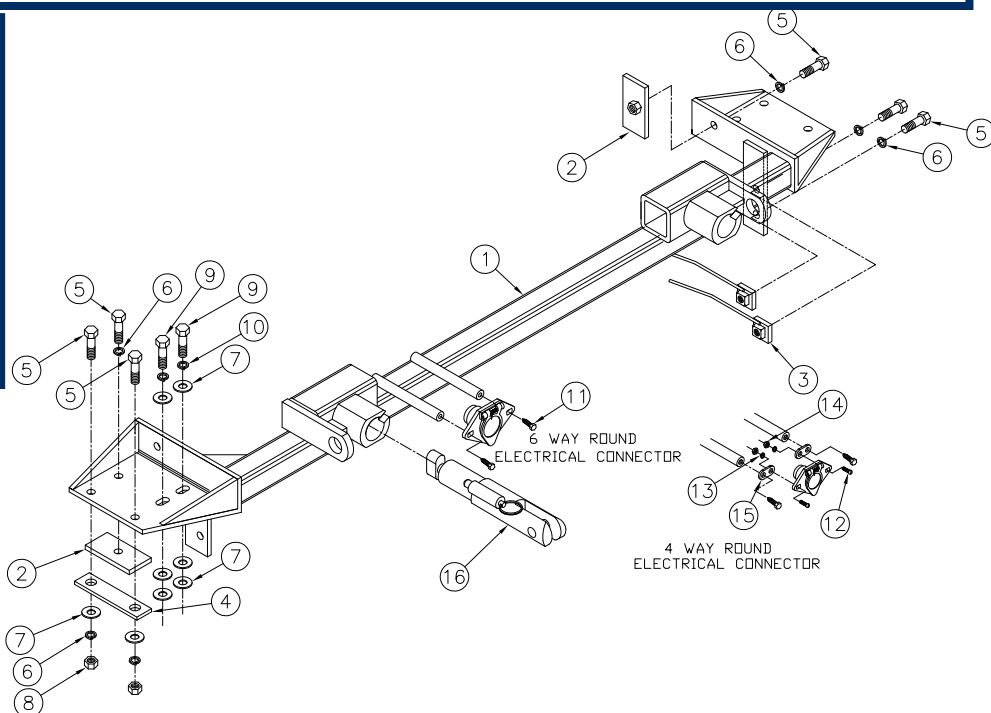

Important:

Use only genuine factory replacement parts on your baseplate. Do NOT substitute homemade or non-typical parts. If a bolt is lost or in need of replacement, for your safety and the preservation of your baseplate, be sure to use a replacement bolt of the same grade (In most cases it will be Grade 5, please reference the parts list above). Replacement parts may be ordered through your nearest Blue Ox® Dealer or Distributor, or call our Customer Care Team at (402)385-3051. Failing to follow and/or altering these installation instructions in either installation or required equipment will void the manufacturer's warranty.

BX2227

2003-05 Honda Pilot

Installation Instructions

Removable Tabs:

Due to the design of the removable tabs, the RangeFinder II tow bar can not be used. Adapters, except for the BX8833 and the BX88151, can not be used with this baseplate.

Instructions:

The front fascia, headlight assemblies and metal bumper are removed and reinstalled for the baseplate installation. Drilling is required. Models with fog lights may need to be trimmed on the back side of the fog light housing.

The dimensional variations between otherwise identical vehicles can be considerable. While the baseplate was designed for easy installation, it may be necessary to tailor the baseplate slightly to compensate for auto manufacturer's tolerances. These minor adjustments may include filing a hole slightly, bending electrical rods or bending end plates.

The BX8869 Bulb and Socket Wiring Kit is available for this vehicle.

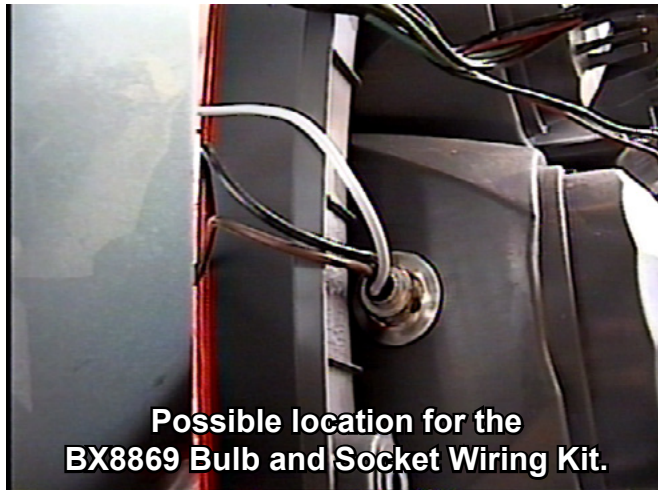

Installation Instructions

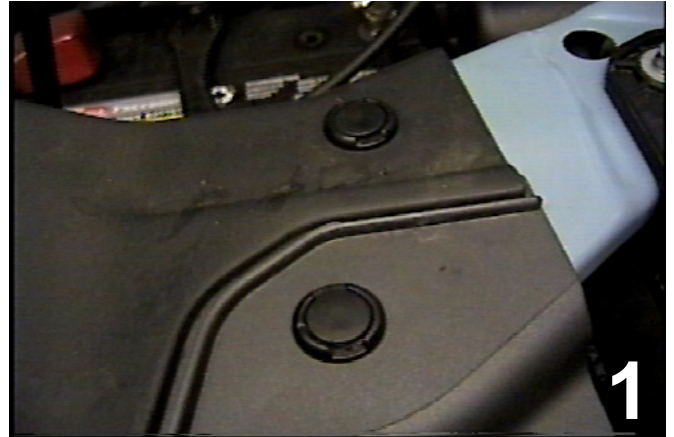

1. Remove thirteen pushpins on the top side of the fascia just above the headlight assemblies. Set pushpins aside to be reinstalled later.



2. Use the 8MM socket to remove a metric bolt from the corner of the fascia just above the front tire. Do this to both sides of the vehicle. Set bolts aside to be reinstalled later.

Handling of some cosmetic parts when installing this product may require the use of protective covers, rags, specialty tools, etc. to prevent damage.

BX2227

2003-05 Honda Pilot

Installation Instructions



3. Just forward of the front tire there are two metric bolts to remove from the underside of the fascia corner with the 10MM socket. Do this on both sides of the vehicle. Disconnect the electrical connections from the fascia. Pull the fascia's corner out to the side, then forward to release and set bolts and fascia aside carefully to be reinstalled later.

NOTE: Some 2005 models may have four push pins from the bottom edge of the fascia to remove before the fascia is removed.

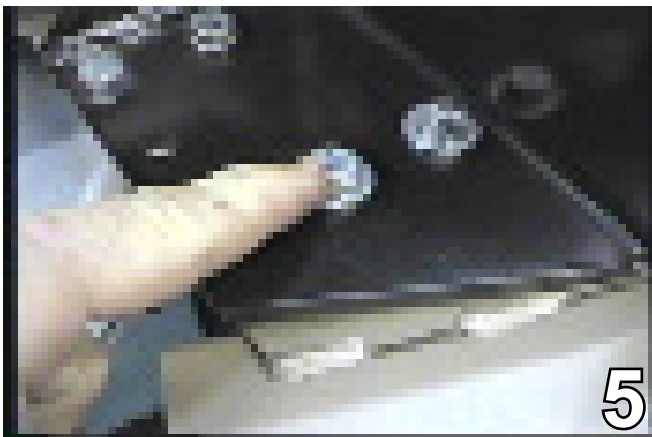

5. Remove the two metric bolts on the top of the metal bumper bracket using a 12MM socket. These bolts will NOT be reused for the installation.

When using power drills be aware of the dangers of torque and drill bit length.



4. Using the 10MM socket, remove the five metric bolts from the driver's side headlight assembly, pull assembly forward, unplug electrical connections and set aside to be reinstalled later. Do this to both sides of the vehicle.

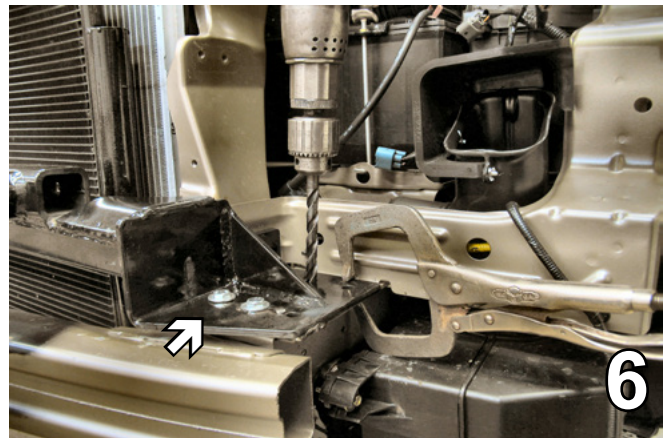

16. Slide metal bumper back on to the frame rail, guiding the baseplate on top of frame rail. Align with the existing holes of the bumper bracket. Insert two 8MM-1.25 x 30MM hex bolts through the baseplate into the two existing bumper bracket holes using 8MM lock washers, and 3/8" flat washers (see arrow). Using a vice grip; clamp the rear of the baseplate. Using the baseplate as a template, drill into the frame rail through the remaining baseplate holes (six). Three are found on the top of the baseplate, another on the side resting against the radiator support. Two more are on the lower portion of the baseplate resting against the side of frame rail. Do this to both sides of the vehicle.

BX2227

2003-05 Honda Pilot

Installation Instructions

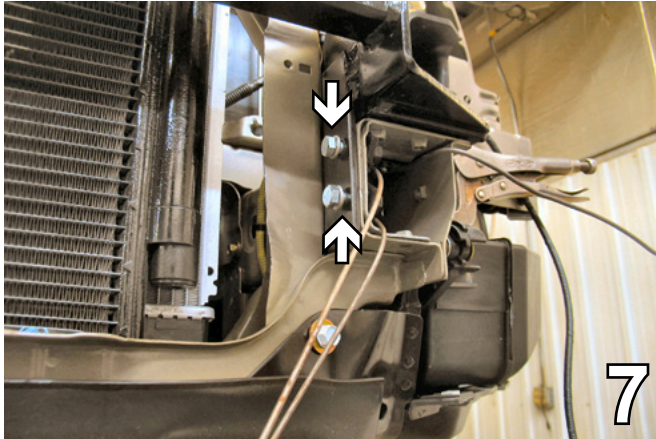

7. Using the 12MM socket, remove metric bolts from the top and bottom of metal bumper and set metal bumper aside to be reinstalled later. Set baseplate in place with drilled holes. Insert the 3/8"/14" nut plates into the frame end and start the 3/8-16 x 1 1/2" hex bolts and the 3/8" lock washers, do **NOT** tighten.

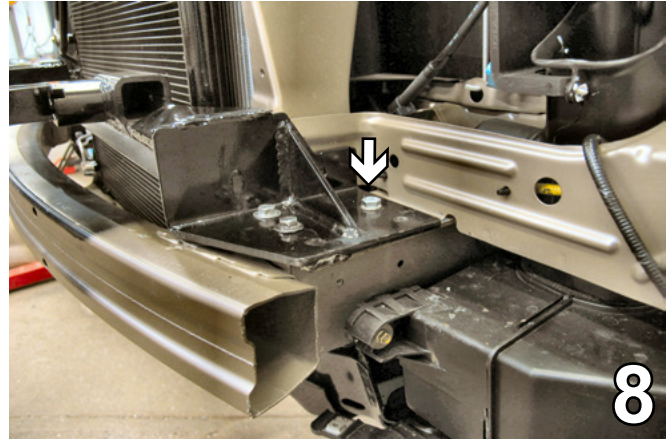

8. Slide the metal bumper between baseplate and frame to align with existing holes. Use the 3/8" flat washer between the metal bumper and the baseplate to level as needed, vehicles may vary. Tighten the 8MM-1.25 x 30MM hex bolts, 8MM lock washers, and the 3/8" flat washers on the top side and existing bolts on the bottom side. Do this to both sides of the vehicle. **BE SURE TO USE LOCTITE Red on ALL bolts.**

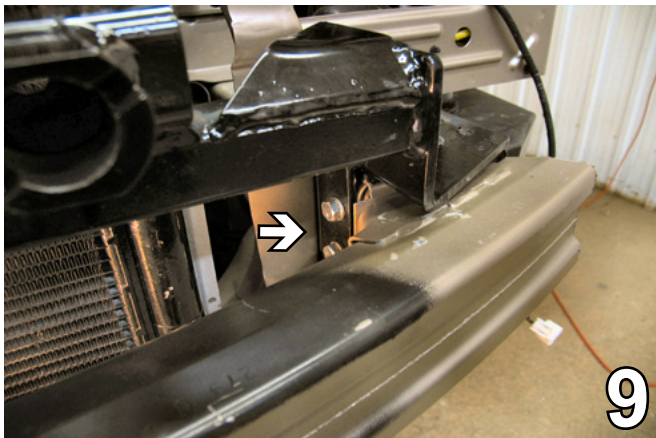

9. Tighten the bolts on the lower portion of the baseplate and all installed bolts in the top of the frame. Do this to both sides of the vehicle.

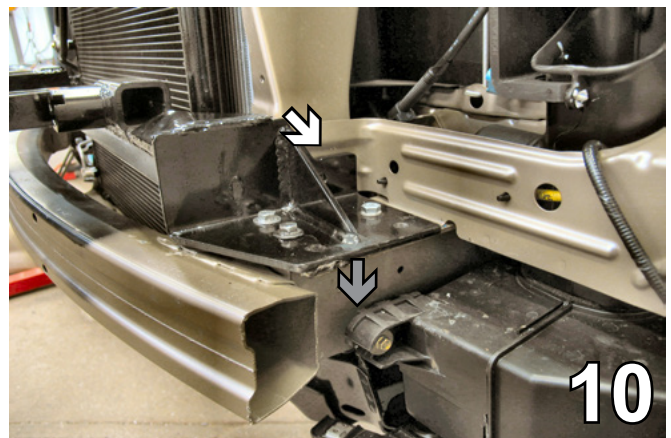

10. Align the nut plate with the drilled hole on the back side of the radiator support and tighten the 3/8-16 hex bolt and lock washer, as (white arrow). Do this to both sides of the vehicle. Using the 10MM socket, remove the metric bolt from the air baffle, (grey arrow), and pull the air baffle down away from the frame.

BX2227

2003-05 Honda Pilot

Installation Instructions

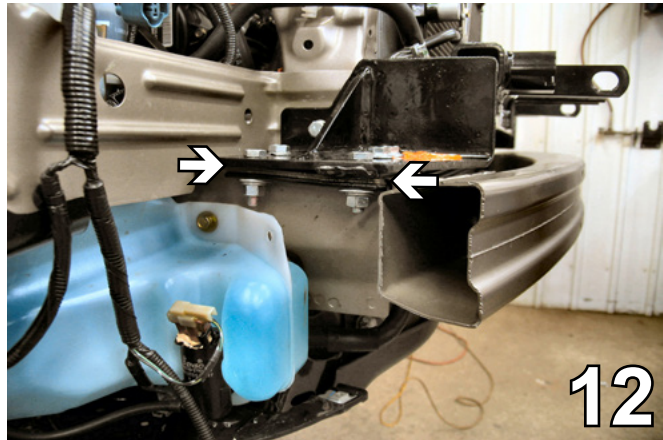
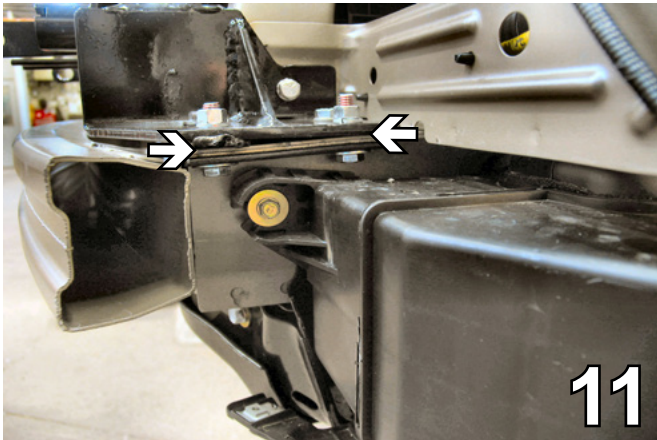

11. Place the backing plate on the bottom side of the frame webbing to align with drilled holes, insert the 3/8-16 x 1 1/2" hex bolts and 3/8" flat washers into this hole, tighten the 3/8-16 hex nuts and 3/8" lock washers. Reinstall the air baffle to its original position.
13. Be sure ALL bolts on baseplate are tightened. Reinstall the headlight assemblies and the fascia, while assuring all electrical components are properly plugged in.

Baseplate Installation is now Complete.

Be sure that ALL electrical connections are plugged in properly and functioning BEFORE Installing the fascia.

12. Place the backing plate on the bottom side of the frame webbing to align with drilled holes, insert the 3/8-16 x 1 1/2" hex bolts and 3/8" flat washer into this hole, tighten the 3/8-16 hex nut and 3/8" lock washers.

Install the tow bar and safety cables according to the instructions included in their packages. When demonstrating this to the customer, be sure to include all of the Blue Ox packaging and contents.

Do not substitute other devices if the tow bar pin and clip are lost.

DEALER OR INSTALLER: BE CERTAIN THE USER RECEIVES THE INSTRUCTION SHEETS FOR THEIR PRODUCTS.

BX2227

2003-05 Honda Pilot

Installation Instructions



Shown without Removable Tabs Installed.



Shown with Removable Tabs Installed.

If the baseplate is in an accident, it must be replaced. DO NOT use it again! An accident can cause unseen damage and using it again could result in more damage or serious injury. DO NOT use the baseplate if it is damaged or missing parts.

CUSTOMER SERVICE COMMITMENT

Blue Ox is committed to providing you with exceptional customer care throughout your lifetime with our products. Our team is here to assist you with any questions you may have regarding the performance of your product. Simply call 1-800-228-9289 and you can speak with our customer care team.

Additionally, please visit our website to see which rallies our Destination America team will be attending. For a nominal fee, our service technician will service your towing system to ensure it's in proper working condition. Also as a commitment to our customers, should you visit our factory you can stay at our full service Blue Ox campground at no charge along with enjoying a factory tour.

Again thank you for being our customer and for the confidence you have shown in the performance of our products. It is because of customers like you we enjoy the success we have today.



© 2005, 08, 10, 11 Blue Ox
One Mill Road, Industrial Park
Pender, Nebraska 68047
Phone: (402) 385-3051
Toll Free: (888) 425-5382
Fax: (402) 385-3360
www.blueox.com
2/14/11