



LoadLIFTER 5000™

S E R I E S

Installation
Guide



Chevrolet Silverado/GMC Sierra

Kits 57204 | 88204 | 89204
57211 | 88211

For maximum effectiveness and safety, please read these instructions completely before proceeding with installation.

IDENTIFYING THE DIFFERENCES BETWEEN KITS

Should you need to contact Air Lift customer service, you will need to know which kit you are inquiring about: standard LoadLifter 5000, LoadLifter 5000 Ultimate or LoadLifter 5000 Ultimate Plus. The kits are easily identifiable by looking at the roll plates and air lines.

- Standard **LoadLifter 5000** — Zinc-plated steel roll plates and black nylon air lines.
- LoadLifter 5000 Ultimate** — Black powder-coated roll plates and black nylon air lines.
- LoadLifter 5000 Ultimate Plus** — Stainless steel roll plates, braided stainless steel air lines, stainless steel air spring mounting hardware.



LoadLifter 5000
silver zinc-plated steel
roll plate



LoadLifter 5000 Ultimate
black powder-coated
roll plate



LoadLifter 5000 Ultimate Plus
stainless steel
roll plate



LoadLifter 5000
nylon air line



LoadLifter 5000 Ultimate
nylon air line



LoadLifter 5000 Ultimate PLUS
braided stainless steel air line

Air Lift offers two Ultimate Plus upgrade kits:

52300 - Braided stainless steel air line and fittings.

52301 - Stainless steel roll plates, air spring mounting hardware, braided stainless steel air lines and fittings.

TABLE OF CONTENTS

Installation Diagram	2
Hardware and Tools Lists	3
Introduction	4
Notation Explanation	4
Installing the LoadLifter 5000 Series System	5
Getting Started	5
Building the Air Spring Assemblies	9
Installing the Air Spring Assemblies	10
Lower Bracket Installation	13
Installing the Air Lines	14
Installing Nylon Air Lines	14
Installing Braided Stainless Steel Air Lines	15
Installing the Thermal Sleeve	15
Finished Installation	16
Installation Checklist	17
Maintenance and Use Guidelines	17
Minimum and Maximum Pressure	17
Limited Warranty and Return Policy	17

Installation Diagram

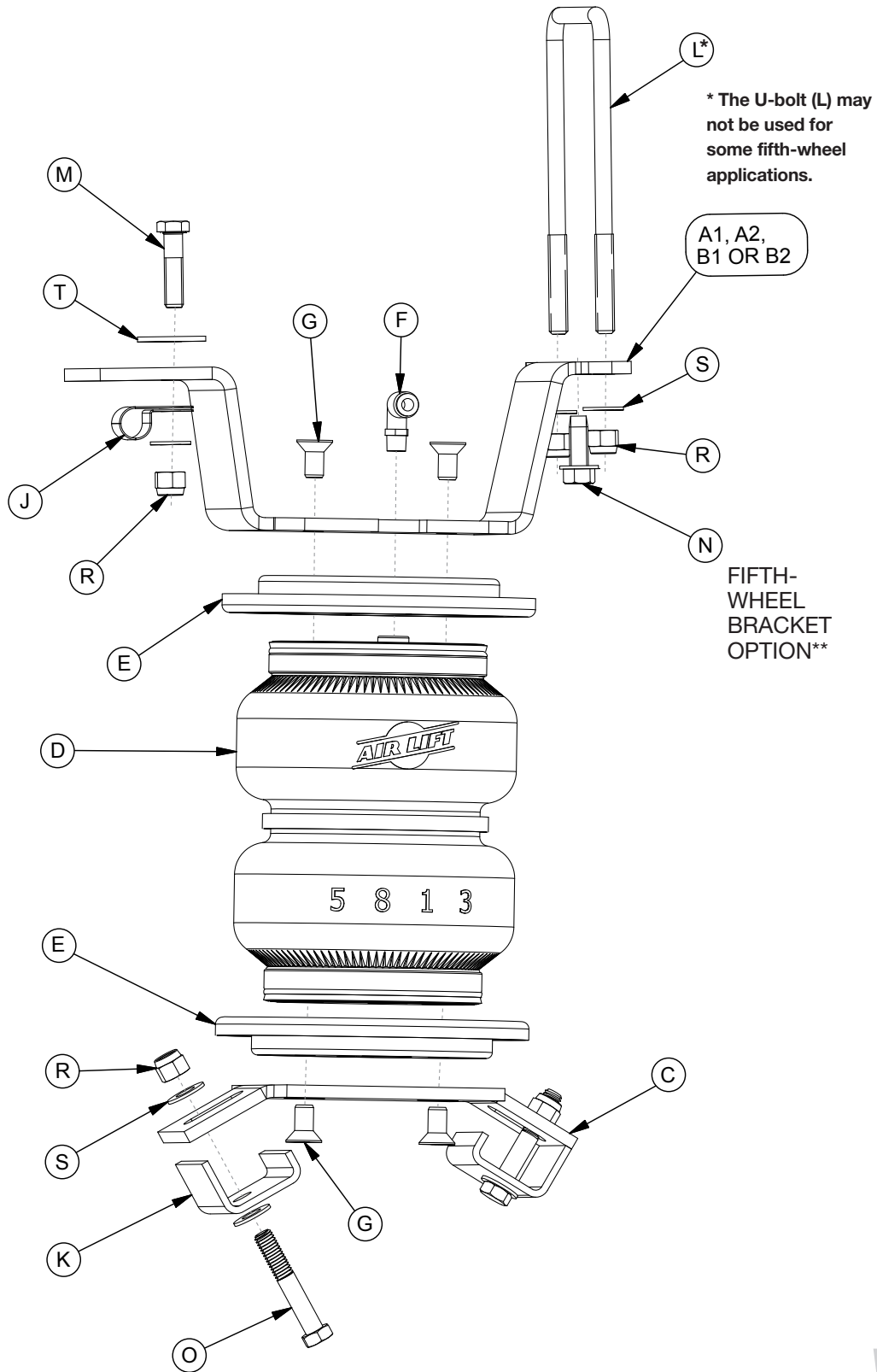

fig. 1

** Refer to figures 23 and 24 (on page 12)

Hardware and Tools Lists

Common Parts Included in All 5 Kits

Item	Part#	Description	Qty
A1	07154	RH Upper bracket.....	1
A2	07040	RH Upper bracket.....	1
B1	07155	LH Upper bracket.....	1
B2	07039	LH upper bracket.....	1
C	03021	Lower bracket.....	2
H*	11968	3/8" Wire leader bolt.....	1
I*	10181	Frame clamp (large).....	1
J	10778	Frame clamp (small)	2
K	01663	J-clamp.....	4
L	11046	U-bolt.....	2
M	17108	3/8"-16 x 1 1/2" Hex-head bolt	2
N	17129	3/8" x 1" Washer head self-tapping screw.....	2
O	17420	3/8"-16 x 2 1/4" Hex-head bolt	4
R	18435	3/8" Nylon lock nut.....	10
S	18444	3/8" Flat washer (small OD).....	14
T	18447	3/8" Flat washer (large OD)	2
U*	09484	Air line thermal sleeve.....	1
V*	17107	3/8"-16 x 1" Hex-head bolt	1
DD*	18501	M8 Stainless steel flat washer.....	2
EE*	21234	Rubber washer	2
FF*	18411	Stainless steel star washer	2
KK*	13955	Spacer	1

* not pictured in the Installation Diagram

TOOLS LIST

Description	Qty
Standard and metric open-end or box wrenches	SET
Ratchet with 9/16" & 1/2" deep-well sockets.....	1
Metric and standard sockets.....	SET
7/32" hex-key wrench (socket if available).....	1
5/16" drill bit (very sharp)	1
Heavy-duty drill	1
Torque wrench.....	1
Standard and metric hex-key wrenches	SET
Hose cutter, razor blade, or sharp knife	1
Hoist or floor jacks	1
Safety stands.....	2
Safety glasses	1
Air compressor or compressed air source.....	1
Spray bottle with dish soap/water solution.....	1
13mm ratcheting wrench.....	1

The photos in this manual show the LoadLifter 5000 Ultimate kit.

Unique Parts in Each Kit

Item	Part#	Description	Qty
D	58437	Air spring	2
E	11951	Roll plate (silver zinc plated).....	4
F	21837	Push-to-connect (PTC) fitting.....	2
G	17215	3/8"-24 x 3/4" Flat-head screw	8
AA*	20086	Air line.....	1
BB*	10466	Zip tie.....	6
CC*	21230	Valve cap	2
GG*	21233	5/16" Hex nut	4

KIT 57204
KIT 57211

LoadLifter 5000

Item	Part#	Description	Qty
D	58496	Air spring with internal jounce bumper.....	2
E	11967	Roll plate (black powder coated).....	4
F	21837	Push-to-connect (PTC) fitting.....	2
G	17215	3/8"-24 x 3/4" Flat-head screw	8
AA*	20086	Air line.....	1
BB*	10466	Zip tie.....	6
CC*	21230	Valve cap	2
GG*	21233	5/16" Hex nut	4

KIT 88204
KIT 88211

LoadLifter 5000™ ULTIMATE

Item	Part#	Description	Qty
D	58496	Air spring with internal jounce bumper.....	2
E	11880	Roll plate (stainless steel)	4
F	21815	AN type fitting.....	2
G	17363	3/8"-24 x 3/4" Stainless steel flat-head screw ...	8
AA*	20987	Stainless steel braided air line.....	2
BB*	10466	Zip tie.....	12
HH*	21709	Fill valve with cap & nut.....	2
II*	21813	PTC to AN adapter fitting	2
JJ*	20084	Air line assembly.....	1

KIT 89204

LoadLifter 5000™ ULTIMATE PLUS+



Missing or damaged parts? Call Air Lift customer service at (800) 248-0892 for a replacement part.

Introduction

The purpose of this publication is to assist with the installation of the LoadLifter 5000 series air spring kits. All LoadLifter 5000 series kits utilize sturdy, reinforced, commercial-grade single or double, depending on the kit, convolute bellows.

The air springs are manufactured like a tire with layers of rubber and cords that control growth. LoadLifter 5000 kits provide up to 5,000 pounds (2,268kg) of load-leveling support with air adjustability from 5-100 PSI (.34-7BAR).

It is important to read and understand the entire installation guide before beginning installation, as well as, read and understand the entire user guide before performing any maintenance, service or repair.

NOTATION EXPLANATION

Hazard notations appear in various locations in this publication. Information which is highlighted by one of these notations must be observed to help minimize risk of personal injury or possible improper installation which may render the vehicle unsafe. Notes are used to help emphasize areas of procedural importance and provide helpful suggestions. The following definitions explain the use of these notations as they appear throughout this guide.

**DANGER**

INDICATES IMMEDIATE HAZARDS WHICH WILL RESULT IN SEVERE PERSONAL INJURY OR DEATH.

**WARNING**

INDICATES HAZARDS OR UNSAFE PRACTICES WHICH COULD RESULT IN SEVERE PERSONAL INJURY OR DEATH.

**CAUTION**

INDICATES HAZARDS OR UNSAFE PRACTICES WHICH COULD RESULT IN DAMAGE TO THE MACHINE OR MINOR PERSONAL INJURY.

Installing the LoadLifter 5000 Series System

GETTING STARTED



COMPRESSED AIR CAN CAUSE INJURY AND DAMAGE TO THE VEHICLE AND PARTS IF IT IS NOT HANDLED PROPERLY. FOR YOUR SAFETY, DO NOT TRY TO INFLATE THE AIR SPRINGS UNTIL THEY HAVE BEEN PROPERLY SECURED TO THE VEHICLE.

1. Raise the vehicle and support the axle with safety stands, setting the safety stands as wide as possible on the axle (fig. 2).

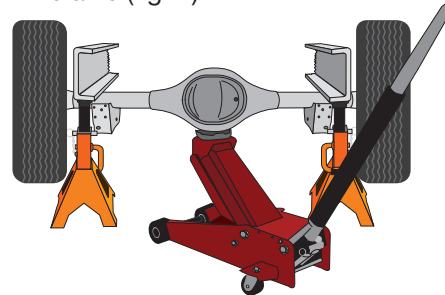

fig. 2

2. Drop the axle or raise the frame up to make room for the assemblies to be put into position between the frame and axle.
3. Remove and discard the line holder located on the left (driver's) side of the frame rail on the inside of the frame, just forward of the axle (fig. 3).

NOTE

Late model line holders may look different than the one pictured in Figure 3.



Inside frame,
left (driver's)
side view

fig. 3

4. Pull up on and remove the pin holding the line holder in place on top of the frame (fig. 4). Unhook the lines and remove the line holder. Discard the line holder.



Outside frame,
left (driver's)
side view

fig. 4

5. Pull the ABS line holders attached to the bottom of the frame, behind the axle, on the left (driver's) and right (passenger's) sides, out from the frame and remove from the ABS line (fig. 5).

fig. 5

6. Use a small screwdriver to unhook the clamp from the line and remove. Discard the clamp.
7. Install the small frame clamps (J) onto the ABS line where the stock line holders were attached with the hole facing forward on the line (fig. 6). Do this for both sides.

 Left
(driver's)
side view

fig. 6

8. Leave the ABS line hanging loose for later installation.

CAUTION

BECAUSE THE EMERGENCY BRAKE CABLE IS IN A LOCATION THAT MAKES IT POSSIBLE TO RUB A HOLE IN THE SIDE OF THE AIR SPRING FLEX MEMBER, IT WILL BE NECESSARY TO RELOCATE IT.

Emergency brake cable modifications for kit #57204, 88204 and 89204 are as follows:

9. Relocate the emergency brake cable that is held by a bracket on the top of the axle center carrier section of the rear end (fig. 7).
10. Remove the top bolt that holds the emergency brake cable bracket onto the center section of the differential cover (fig. 7).
11. Remove the bracket from the emergency brake cable and discard (fig. 7).

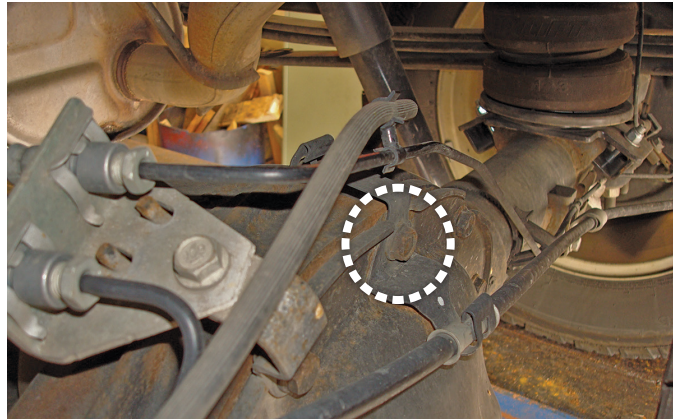

fig. 7

12. Install the large frame clamp (I) over the emergency brake cable facing the rear with the hole down (fig. 8) and attach to the rear end using the stock bolt previously removed.

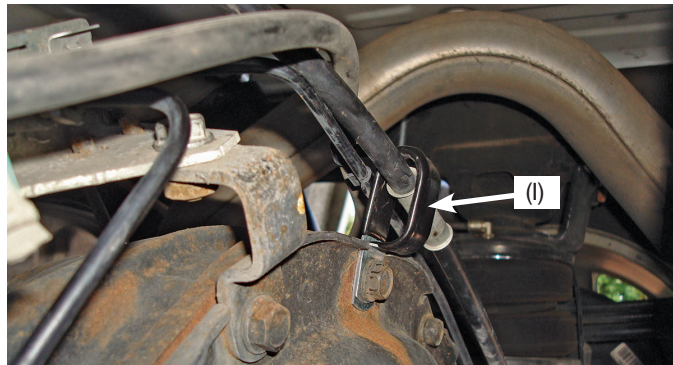

fig. 8

13. Bend the frame clamp slightly to obtain clearance on the hard brake lines mounting to the top of the axle (fig. 9).

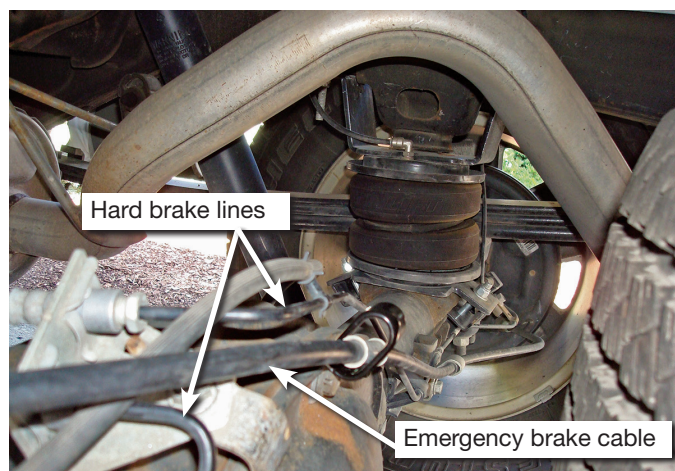

fig. 9

Emergency brake cable modifications for kit numbers 57211, 88211 are as follows:

NOTE

This step will be done in conjunction with step 7 of the "Installing the Air Spring Assemblies" section.

14. Insert the emergency brake cable into the large frame clamp (I) (fig. 10).
15. Install the large frame clamp onto the U-bolt (L), inside the frame on the left (driver's) side with the clamp pointing inboard toward the center of the vehicle (fig. 10).
16. Torque the U-bolt as specified in step 9 if using the U-bolt to mount the upper bracket (fig. 10). If the truck has a fifth-wheel bracket use the center hole, instead of the U-bolt, to mount the upper bracket. Attach the large frame clamp (I) using the 3/8" bolt (V), 3/8" flat washer (S) and nylon lock nut (R) supplied. Tighten to 10 lb.-ft. (14Nm).

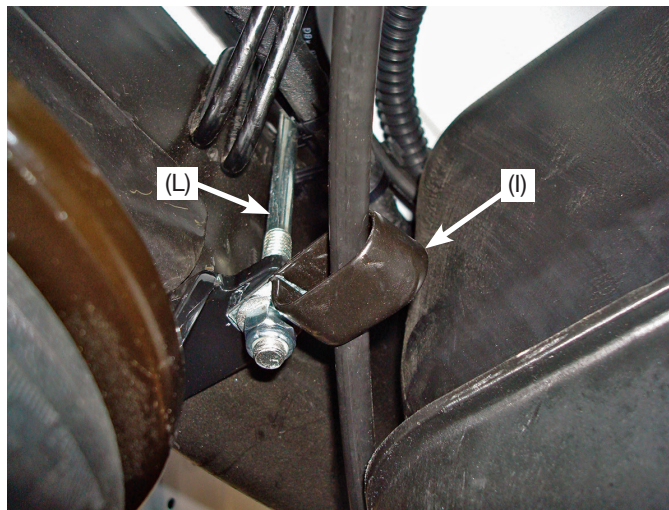

fig. 10

17. Remove the jounce bumper by unbolting it from the jounce bumper mounting cup welded to the frame. Pull or pry the jounce bumper out of the cup with a screwdriver once the bolt has been removed (fig. 11).

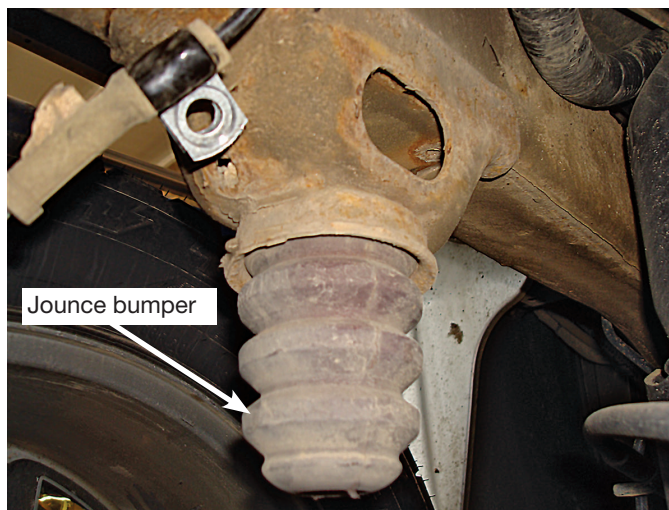

fig. 11

BUILDING THE AIR SPRING ASSEMBLIES

1. Set a roll plate (E) over the top of the air spring (D) (fig. 12).

NOTE

The radiused (rounded) edge of the roll plate (E) will be toward the air spring so that the air spring is seated inside both roll plates.

2. Install the swivel fitting (F) into the top of the air spring finger tight plus one and a half turns. Do not overtighten.

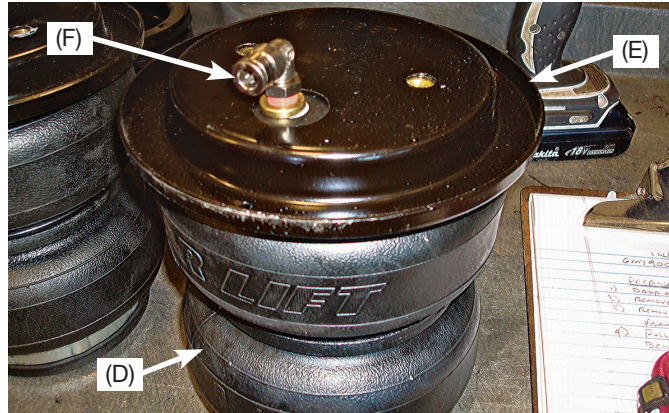

fig. 12

3. Install the upper bracket (A or B) onto the air spring (D) using four flat-head screws (G) (fig. 13). Torque to no more than 20 lb.-ft. (27Nm).

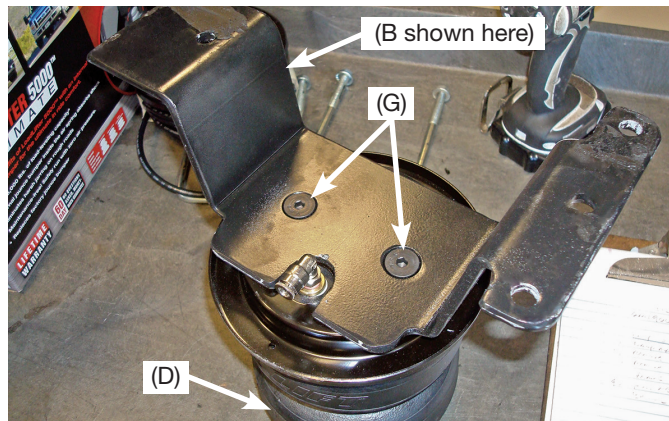

fig. 13

4. Install the lower bracket (C) onto the bottom of the air spring using the flat-head screws (G) (fig. 14). Torque to no more than 20 lb.-ft. (27Nm).

NOTE

The arrow on the lower bracket points to the opposite side of the fitting on the air spring assembly (outboard toward the tire).

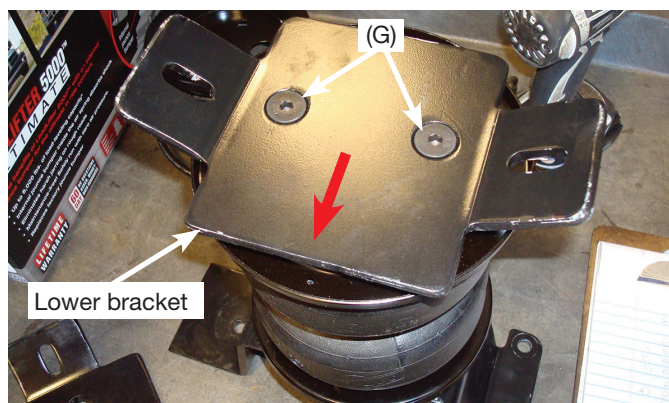
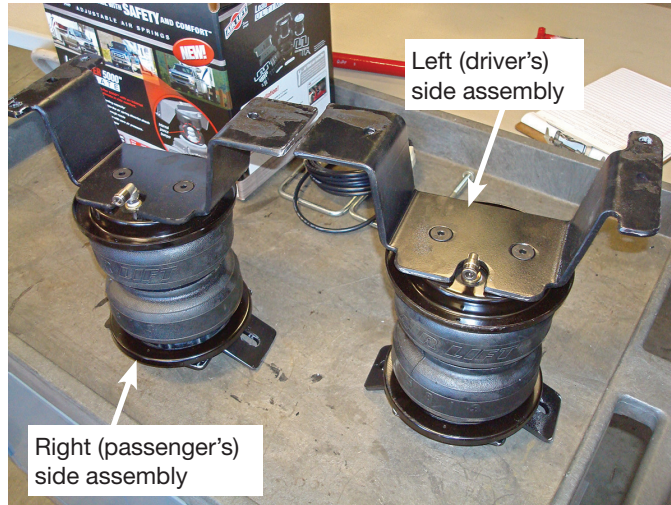

fig. 14

- Figure 15 shows both left and right assemblies ready to install.

fig. 15

INSTALLING THE AIR SPRING ASSEMBLIES

- Install a large flat washer (T) over the hex-head bolt (M) and thread the wire bolt leader tool (H) onto the threads of the bolt (fig. 16).

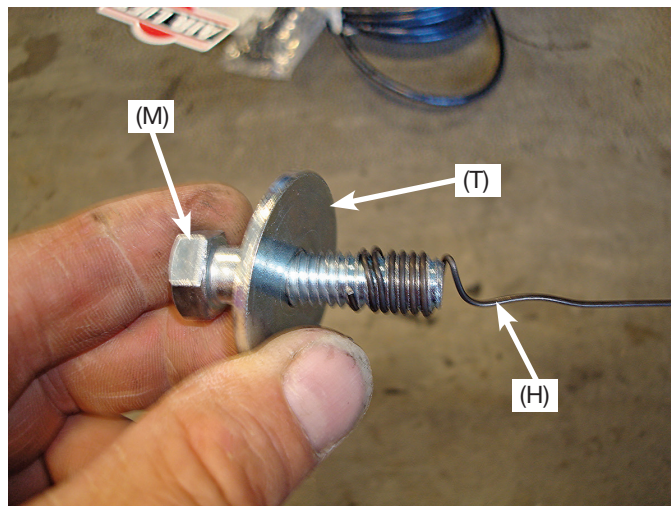
fig. 16

- Insert the bolt and washer through the slot in the side of the frame, and through the slot in the bottom of the frame the ABS line holder was removed (fig. 17). Repeat for the other side.

fig. 17

3. Set the left assembly (with the L on the bracket) on the left (driver's) side of the axle. Repeat for the right (passenger's) side.

NOTE

The fitting on both air springs will be inboard.

4. While raising the assembly, line up the bolt previously installed with the back hole on the bracket. Set the new ABS line holder over the bolt once the upper bracket is in place and cap with a flat washer (S) and nylon lock nut (R) (fig. 18). Leave loose at this time.

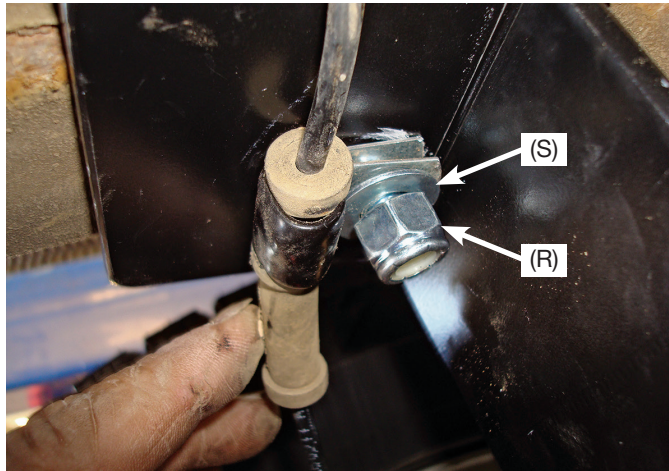

fig. 18

There are two ways to attach the front side of the upper bracket depending on whether the truck has a fifth-wheel bracket running alongside the frame or not.

For vehicles with NO fifth-wheel bracket along the side of the frame, perform the following steps:

NOTE

On late model vehicles, there is a heat shield above and forward of the axle, on the passenger (right) hand side of the vehicle that will be in the way of the U-bolt. For models without a heat shield, proceed to step 7.

CAUTION

HEAT SHIELD HAS SHARP EDGES, USE CAUTION WHEN REMOVING THE BOLT.

5. Using a ratcheting wrench, remove the bolt that holds the heat shield on the frame above and forward of the axle. Set the bolt aside (fig. 19).
6. Set a U-bolt (L) into position around the frame (fig 20). Set spacer (KK) between the frame and heat shield and reattach the heat shield with the stock bolt previously removed.

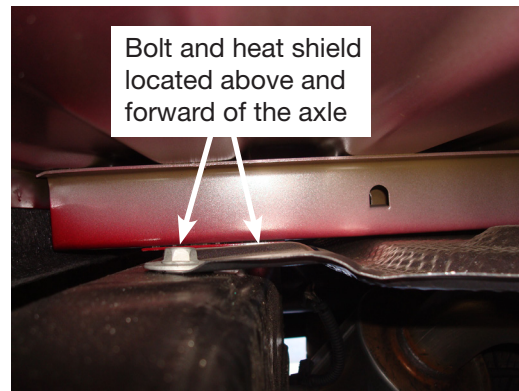

fig. 19

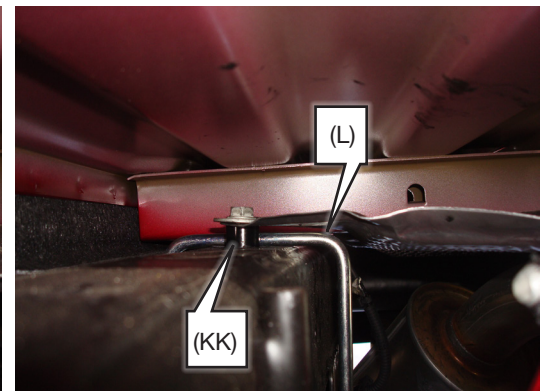
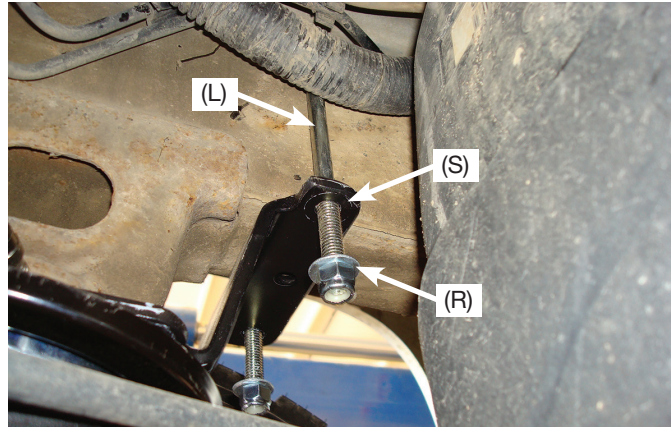

fig. 20

7. For models without a heat shield as shown in Figure 19, set a U-bolt (L) into position around the frame (Fig. 20) and insert the U-bolt (L) through the holes in the upper bracket forward of the axle (Fig. 21).

fig. 21

CAUTION

DO NOT PINCH THE LINES ON THE LEFT (DRIVER'S) SIDE FRAME RAIL.

8. Cap with flat washers (S) and nylon lock nuts (R). Position the front upper bracket onto the frame rail so the center hole is in the middle of the frame and there is sufficient clearance between the fitting and the stock jounce bumper cup.
9. Torque the U-bolts to 10 lb.-ft. (14Nm). Repeat for the other side.
10. Figure 22 shows the U-bolt installed on models that have the heat shield above the axle with spacer installed on passenger's (right) side, forward of the axle. Continue with Lower Bracket Installation.

fig. 22

For vehicles with a fifth-wheel hitch bracket that runs alongside the frame, perform the following steps:

11. Center the upper bracket in the middle of the frame rail, make sure there is sufficient clearance between the fitting and the stock jounce bumper cup, and drill a 5/16" hole in the frame using the center hole in the front side of the upper bracket as a template (fig. 23). Install the washer-head self-tapping screw (N) in the hole (fig. 24). Torque to 15 lb.-ft. (20Nm). Repeat for the other side.

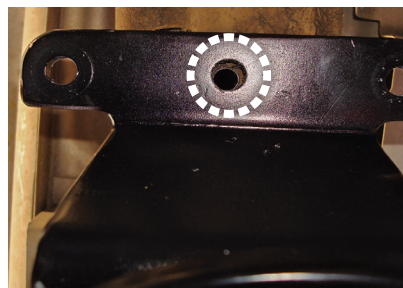
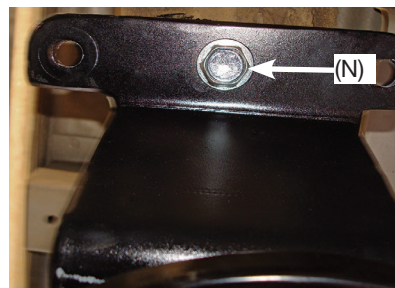
fig. 23

fig. 24

12. Finish the upper bracket installation by torquing the rear bolt to 15 lb.-ft. (20Nm) then continue to the “Lower Bracket Installation” section.

NOTE

Use a 1/4”-drive ratchet and long 9/16” socket through the hole in the side of the frame to hold the rear mounting bolt for torquing (fig. 25).

Long-box models (kit numbers 57211 and 88211) may require a short extension.

TECH TIP

Use the wire leader bolt tool (H) to help retrieve the extension and socket from inside the frame. Insert the short extension through the coil end of the tool (fig. 26). ww



fig. 25



fig. 26

LOWER BRACKET INSTALLATION

1. Push the lower bracket (C) forward or back to center it over the jounce bumper strike plate. Insert a hex-head bolt (O) through a flat washer (S) and J-clamp (K) (fig. 27). Install the J-clamp with the short end under the jounce bumper strike plate with the bolt through the lower bracket. Cap with a flat washer (S) and nylon lock nut (R). Do this on the front and rear of the lower bracket and evenly torque both sides to 10 lb.-ft. (14Nm) keeping the lower bracket centered over the jounce bumper strike plate on the axle. Repeat for the other side.

NOTE

It may be necessary on some models to slightly pull down the hard brake line on the rear right (passenger's) side in order to install the lower bracket mounting hardware.

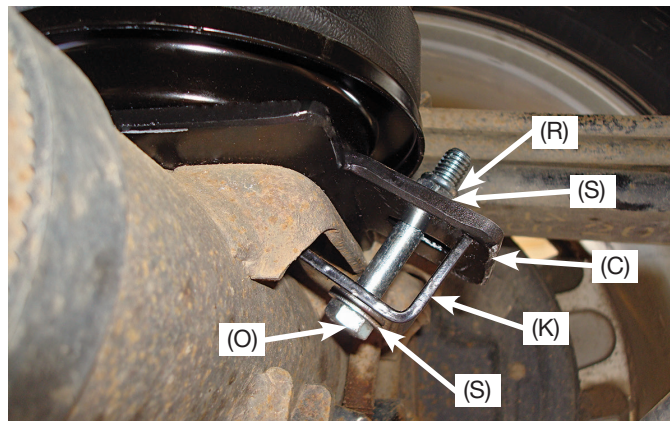
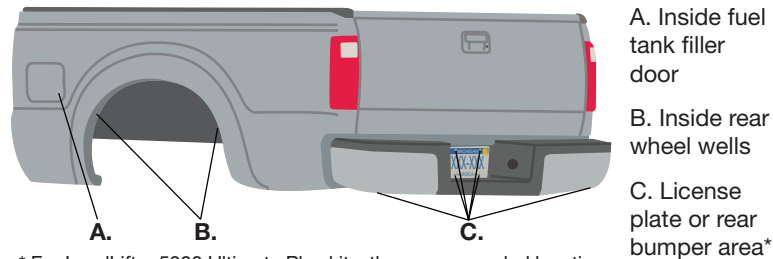

fig. 27

Installing the Air Lines

Air lines are routed from the air springs to Schrader valves. LoadLifter 5000 series air lines come in two styles: nylon and braided stainless steel. Begin by choosing locations for the Schrader valves and drill a 5/16" (8mm) hole, if necessary (Fig. 28).



* For LoadLifter 5000 Ultimate Plus kits, the recommended location for the Schrader valves is the rear bumper area or license plate.

fig. 28

CAUTION

KEEP AT LEAST 6" (150MM) OF CLEARANCE BETWEEN ALL AIR LINES AND THE EXHAUST SYSTEM. AVOID SHARP BENDS AND EDGES.

INSTALLING NYLON AIR LINES

1. Cut the air line in half. Make clean, square cuts with a razor blade or hose cutter (Fig. 29). Do not use scissors or wire cutters.

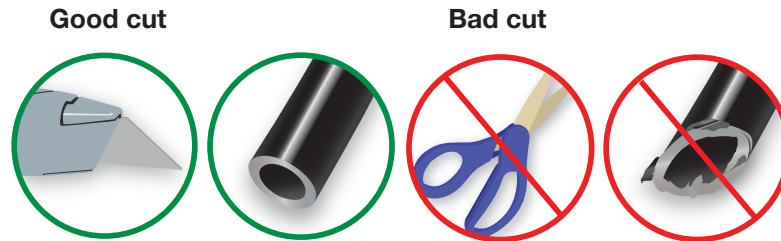

fig. 29

2. Use zip ties to secure the air line to fixed points along the chassis. Do not pinch or kink the air line. The minimum bend radius for the air line is 1" (25mm). Leave at least 2" (50mm) of slack in the air line to allow for any movement that might pull on the air line.
3. Install the Schrader valve in the chosen location (Fig. 30).

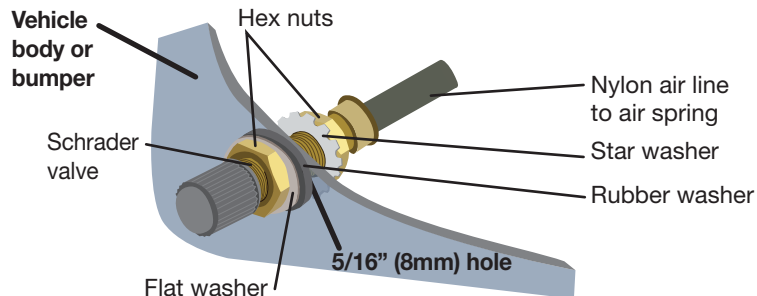

fig. 30

INSTALLING BRAIDED STAINLESS STEEL AIR LINES

CAUTION

KEEP THE AIR LINE AWAY FROM THE FUEL LINE, BRAKE LINES AND ELECTRICAL WIRES.

1. Use zip ties to secure the air line to fixed points along the chassis every 6" to 8" (150 to 203mm). Leave at least 2" (50mm) of slack to allow for any movement that might pull on the air line.
2. Tighten the air line hex nut finger tight, then use 2 wrenches to turn 1 additional flat (1/6 of one full turn). **Do not overtighten** (figs. 31 or 32). The easiest way to tighten the fitting is off the vehicle. Install the Schrader valve in the chosen location.
3. Coil and secure any excess air line in an area where it will not be susceptible to damage. The braided stainless steel air line cannot be trimmed.

Air Line Setup Without Compressor System

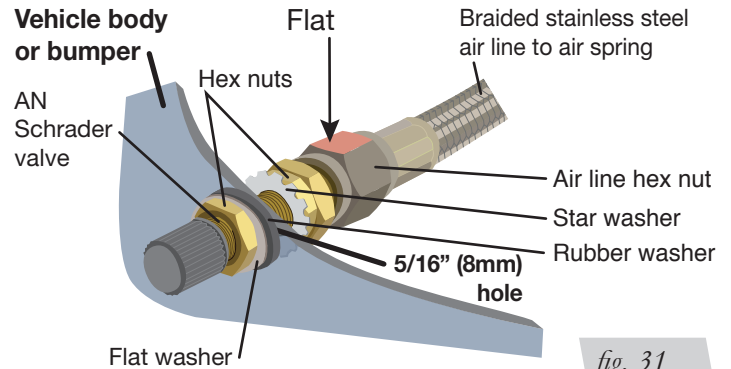

fig. 31

Air Line Setup for Compressor Integration

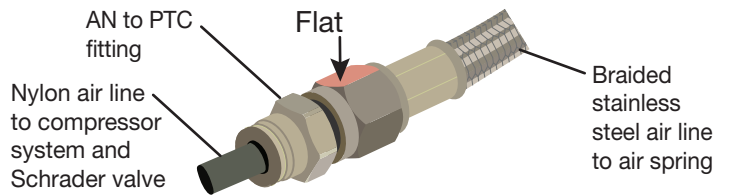

fig. 32

INSTALLING THE THERMAL SLEEVE

1. Slide the air line thermal sleeve (U) over the air line and place it where the air line is closest to the exhaust (fig. 33).

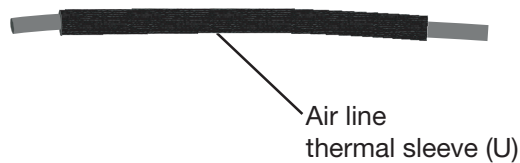

fig. 33

Finished Installation

1. Left (driver's) side installation shown (fig. 34).

NOTE

This upper bracket is shown mounted with the U-bolts and would be the non-fifth-wheel hitch mounting option.



fig. 34

2. Tie off the hose to the front hole or U-bolt, depending on the mounting, with a zip tie to keep the hose away from the exhaust.
3. Right (passenger's) side installation shown (fig. 35).

NOTE

This upper bracket is shown mounted with the fifth-wheel hitch mounting option (no U-bolt mounting).



fig. 35

INSTALLATION CHECKLIST

- Clearance test** — Inflate the air springs to 40-60 PSI (2.8-4.1BAR) and make sure there is at least 1/2" (13mm) clearance from anything that might rub against each sleeve. Be sure to check the tire, brakes, frame, shock absorbers and brake cables.
- Leak test before road test** — Inflate the air springs to 40-60 PSI (2.8-4.1BAR) and check all connections for leaks. All leaks must be eliminated before the vehicle is road tested.
- Heat test** — Be sure there is sufficient clearance from heat sources, at least 6" (152mm) for air springs and air lines. If a heat shield was included in the kit, install it. If there is no heat shield, but one is required, call Air Lift customer service at **(800) 248-0892**.
- Fastener test** — Recheck all bolts for proper torque.
- Road test** — The vehicle should be road tested after the preceding tests. Inflate the springs to recommended driving pressures. Drive the vehicle 10 miles (16km) and recheck for clearance, loose fasteners and air leaks.
- Operating instructions** — If professionally installed, the installer should review the operating instructions with the owner. Be sure to provide the owner with all of the paperwork that came with the kit.

Maintenance and Use Guidelines

1. Check air pressure weekly.
2. Always maintain normal ride height. Never inflate beyond 100 PSI (7BAR).
3. If the system develops an air leak, use a soapy water solution to check all air line connections and the inflation valve core before deflating and removing the air spring.

Minimum Recommended Pressure	Maximum Air Pressure
5 PSI (.34BAR)	100 PSI (7BAR)

CAUTION

FOR SAFETY AND TO PREVENT POSSIBLE DAMAGE TO THE VEHICLE, DO NOT EXCEED MAXIMUM GROSS VEHICLE WEIGHT RATING (GVWR) OR PAYLOAD RATING, AS INDICATED BY THE VEHICLE MANUFACTURER.

CAUTION

ALTHOUGH THE AIR SPRINGS ARE RATED AT A MAXIMUM INFLATION PRESSURE OF 100 PSI (7BAR), THE AIR PRESSURE ACTUALLY NEEDED IS DEPENDENT ON LOAD AND GROSS VEHICLE WEIGHT RATING.

Limited Warranty and Return Policy

Air Lift Company provides a limited lifetime warranty to the original purchaser of its load support products, that the products will be free from defects in workmanship and materials when used on cars and trucks as specified by Air Lift Company and under normal operating conditions, subject to the requirements and exclusions set forth in the full Limited Warranty and Return Policy that is available at www.airliftcompany.com/warranty.

For additional warranty information contact Air Lift Company customer service.



Thank you for purchasing Air Lift Products – the professional Installer's choice!

Need Help?

Contact Air Lift Company Customer Service at (800) 248-0892
or email service@airliftcompany.com.

For calls outside the U.S. or Canada, dial (517) 322-2144.

Air Lift Company • 2727 Snow Road • Lansing, MI 48917 or P.O. Box 80167 • Lansing, MI 48908-0167

